

MANUAL TÉCNICO DE PRODUCTOS

EDICIÓN DE 2022

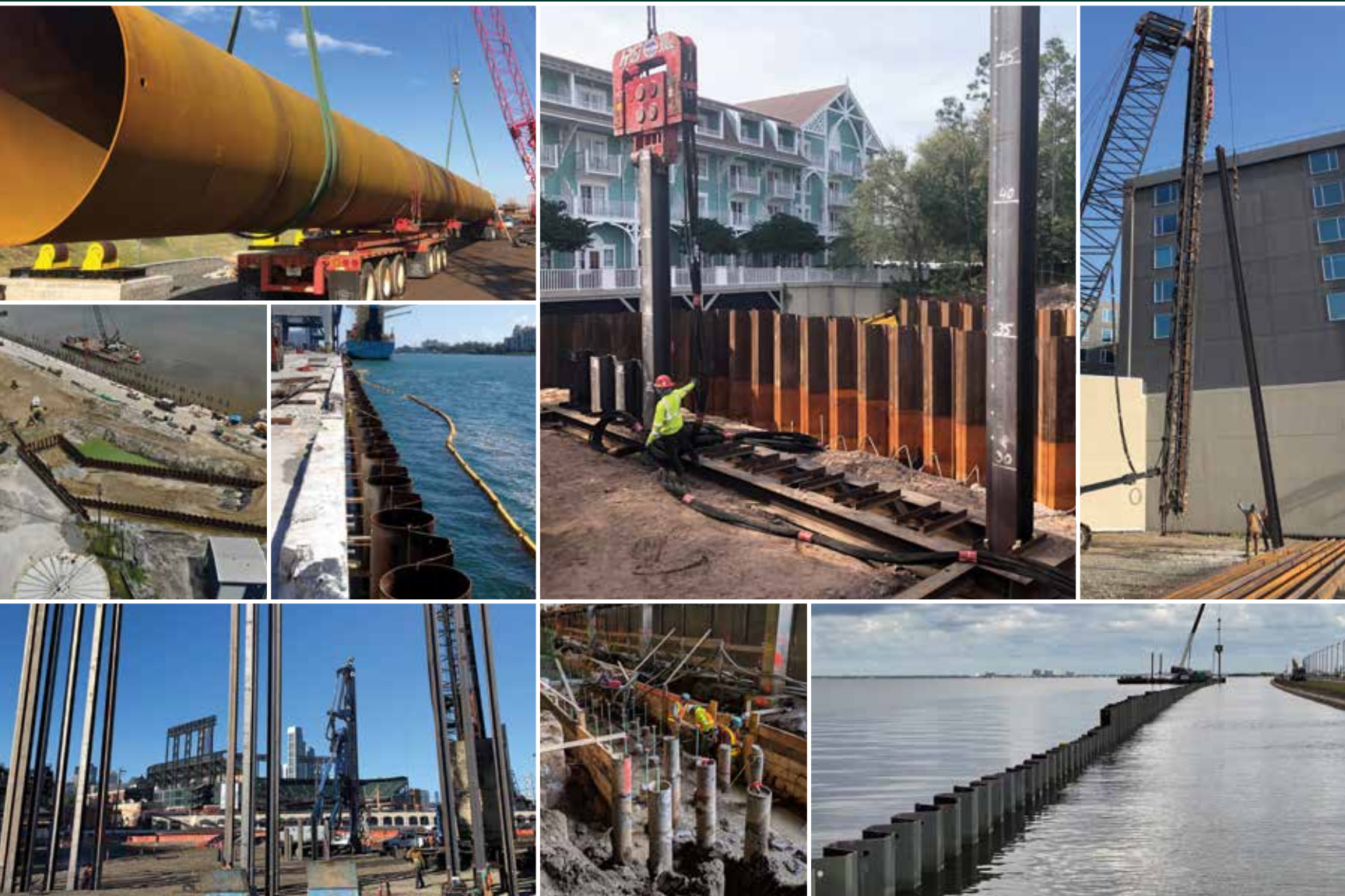

NUCOR[®]
SKYLINE

UNA GAMA INIGUALABLE DE PRODUCTOS

Como la principal compañía proveedora de soluciones en acero estructural para cimentaciones y edificios, Nucor Skyline ofrece una variedad incomparable de productos. Desde tablestacas de acero laminadas en caliente y en frío hasta pilotes-H, pilotes tubulares y productos geoestructurales, sólo Nucor Skyline ofrece la gama de productos que satisface las demandas de diseño y construcción en todo el continente americano.

DISPONIBILIDAD DE MATERIALES

Gracias a la ubicación estratégica de sus almacenes en toda América, Nucor Skyline ha establecido una red de entrega de materiales preparada para una respuesta inmediata. Nuestras instalaciones ofrecen opciones de transporte multimodal, para una entrega económica y puntual.

CAPACIDAD DE FABRICACIÓN

Nucor Skyline posee y opera plantas de pilotes tubulares, tablestacas, barras roscadas y accesorios para pilotes. La producción se complementa con una alta capacidad de ensamblaje para brindarle una fuente única de soluciones para todas sus necesidades de cimentación.

EXPERIENCIA EN ASISTENCIA DE VENTAS E INGENIERÍA

Nucor Skyline posee oficinas de ventas en toda América con un equipo de profesionales experimentados que le ayudarán a cubrir sus necesidades de materiales. Además, sólo Nucor Skyline ofrece excelente asistencia de ingeniería para el diseño y construcción de proyectos.



ÍNDICE

Tabla de equivalencias	2
Tablestacas de acero	3
Tablestacas de acero laminadas en caliente NZ	5
Tablestacas de acero laminadas en frío SCZ/SKZ	7
Tablestacas de acero laminadas en frío SKL/SKS	9
Tablestacas de acero laminadas en caliente PS	11
Sistemas de muros combinados	13
Pilotes H	17
Tuberías	21
Perfiles estructurales	33
Vigas	35
Canales y Ángulos	58
Accesorios de pilotes	59
Soluciones geoestructurales	63
Barras roscadas y accesorios	65
Sistemas de barras huecas	73
Encoframiento encordado para micropilotes	77
Sistemas de anclajes multitrenzas	80

TABLA DE EQUIVALENCIAS

	Métrico a imperial		Imperial a métrico			
Dimensiones	1 cm	=	0.3937 in	1 in	=	2.5400 cm
	1 m	=	3.2808 ft	1 ft	=	0.3048 m
	1 cm ²	=	0.1550 in ²	1 in ²	=	6.4516 cm ²
	1 m ²	=	10.7639 ft ²	1 ft ²	=	0.0929 m ²
	1 cm ³	=	0.0610 in ³	1 in ³	=	16.3870 cm ³
	1 m ³	=	35.3149 ft ³	1 ft ³	=	0.0283 m ³
	1 cm ² /m	=	0.0472 in ² /ft	1 in ² /ft.	=	21.166 cm ² /m
Peso, fuerza, presión	1 N	=	0.2247 lb	1 lb	=	4.4497 N
	1 N/mm	=	5.7082 lb/in	1 lb/in	=	0.1752 N/mm
	1 N/m	=	0.0685 lb/ft	1 lb/ft	=	14.5989 N/m
	1 N/cm ²	=	1.4499 lb/in ²	1 lb/in ²	=	0.6897 N/cm ²
	1 N/m ²	=	0.0209 lb/ft ²	1 lb/ft ²	=	47.8968 N/m ²
	1 N/cm ³	=	3.6827 lb/in ³	1 lb/in ³	=	0.2715 N/cm ³
	1 N/m ³	=	0.0064 lb/ft ³	1 lb/ft ³	=	1571420 N/m ³
	1 kg	=	2.2046 lbs	1 lb	=	0.4536 kg
	1 kg/m	=	0.6720 lb/ft	1 lb/ft	=	1.4882 kg/m
	1 kg/m ²	=	0.2048 lb/ft ²	1 lb/ft ²	=	4.8824 kg/m ²
	1 Tonelada Métrica	=	1.1023 Tonelada US	1 Tonelada US	=	0.9072 Toneladas Métricas
Momento de inercia	1 cm ⁴	=	0.0240 in ⁴	1 in ⁴	=	41.6228 cm ⁴
	1 cm ⁴ /m	=	0.0073 in ⁴ /ft	1 in ⁴ /ft	=	136.5582 cm ⁴ /m
Módulo de sección	1 cm ³	=	0.0610 in ³	1 in ³	=	16.3870 cm ³
	1 cm ³ /m	=	0.0186 in ³ /ft	1 in ³ /ft	=	53.7631 cm ³ /m
Momento flector	1 Nm	=	0.7373 lb.ft	1 lb.ft	=	1.3563 Nm
	1 Nm/m	=	2.6968 lb.in/ft	1 lb.in/ft	=	0.3708 Nm/m
	1 Nm/m	=	0.2247 lb.ft/ft	1 lb.ft/ft	=	4.4497 Nm/m

TABLESTACAS DE ACERO

Nucor Skyline abastece una amplia gama de tablestacas de fabricantes líderes en su ramo.

Tablestacas laminadas en caliente y frío

La laminación en frío y en caliente son dos métodos primarios de la manufactura de tablestacas. A pesar de que hay diferencias fundamentales entre estos dos métodos, la diferencia más importante es la interconexión. Ya que las tablestacas laminadas en caliente se producen con acero a altas temperaturas, la interconexión tiende a ser más ajustada que la de su contraparte laminada en frío. Normalmente, los conectores más sueltos no se recomiendan en condiciones de hinca extremadamente severas o para muros que requieren baja permeabilidad.

Aplicaciones de las tablestacas

Alrededor del mundo, la tablestaca se utiliza para un sinnúmero de aplicaciones. La tablestaca Z, nombrado así por su forma, se utiliza comúnmente para ataguías, refuerzo de diques, estructuras de retención, rompeolas y espigones. Además de estas aplicaciones tradicionales, las tablestacas también se utilizan para conformar los estribos de puentes, muros de contención ambientales, estacionamientos subterráneos, y caminos y vías férreas a desnivel. Las tablestacas pueden servir como un miembro estructural permanente.

El diseño de las tablestacas se basa en sus propiedades de flexión, módulos de sección y momento de inercia. Asimismo, se toman en cuenta la durabilidad y capacidad de manejo de cada sección.

Las tablestacas planas se utilizan en la construcción de estructuras celulares. Las ataguías celulares se utilizan para desecar grandes áreas durante la construcción de esclusas y presas, y también se emplean como muros permanentes cuando las cargas son excepcionalmente altas o hay muy poco o nada de suelo para empotramiento. Ya que las células son estructuras de gravedad, el empotramiento es por lo general innecesario. El peso y tensión de las células en las tablestacas planas ayudan a que las células individuales permanezcan juntas y mantengan su estabilidad. La tensión de los elementos se transmite mediante la conexión. A diferencia de las paredes de las tablestacas Z o pantallas combinadas, la resistencia de la conexión es la consideración principal del diseño.

Orificios de izaje

Los orificios de izaje son estándar para todas las secciones de tablestacas. Se encuentran en la línea central de cada sección.

Y = 152.4 mm

Ø = 63.5 mm – 66.7 mm

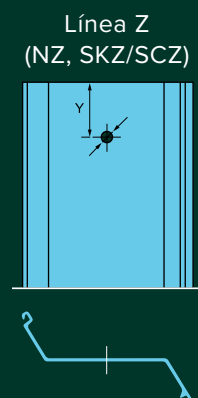



Fort McMurray, AB



Savannah, GA

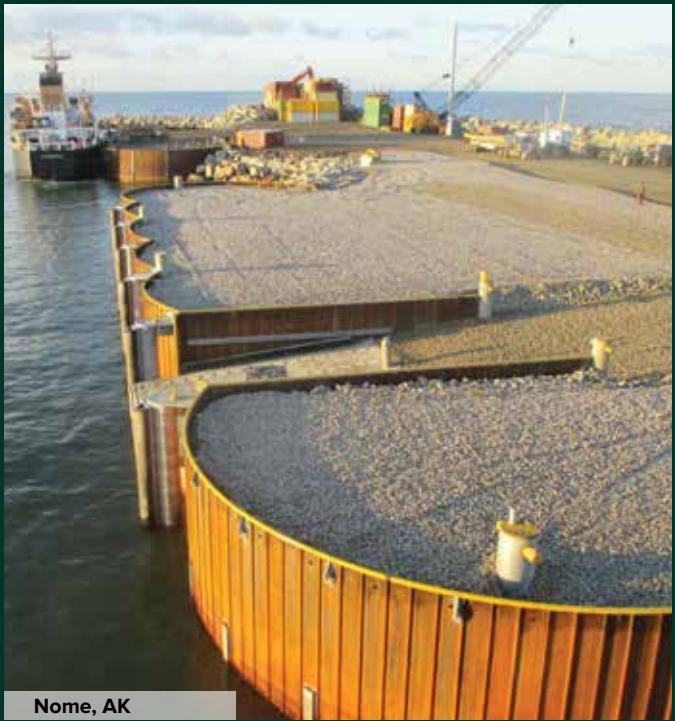

Nome, AK

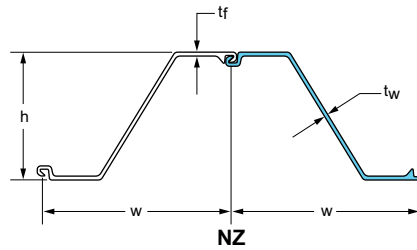

SECCIÓN	ESPESOR				Sección transversal cm ² /m in ² /ft	PESO		MÓDULO DE SECCIÓN			ÁREA DE REVESTIMIENTO	
	Ancho (w) mm in	Altura (h) mm in	Patín (t _f) mm in	Alma (t _w) mm in		Pilote kg/m lb/ft	Pared kg/m ² lb/ft ²	Elástico cm ³ /m in ³ /ft	Plástico cm ³ /m in ³ /ft	Momento de inercia cm ⁴ /m in ⁴ /ft	Ambos lados m ² /m ft ² /ft	Superficie de la pared m ² /m ² ft ² /ft ²
NZ14	770 30.31	340 13.39	9.5 0.375	9.5 0.375	135.4 6.40	81.85 55	106.30 21.77	1379 25.65	1640 30.50	23447 171.7	1.86 6.10	1.20 1.20
NZ19	700 27.56	410 16.14	9.5 0.375	9.5 0.375	149.6 7.07	82.23 55	117.40 24.05	1886 35.08	2222 41.33	38659 283.1	1.88 6.18	1.35 1.35
NZ20	700 27.56	411 16.16	10.0 0.394	10.0 0.394	155.4 7.34	85.37 57	122.00 24.82	1948 36.24	2301 42.80	39984 292.8	1.88 6.18	1.35 1.35
NZ21	700 27.56	412 16.20	11.0 0.433	11.0 0.433	165.2 7.80	90.78 61	129.70 26.56	2080 38.69	2465 45.85	42797 313.4	1.88 6.18	1.35 1.35
NZ26	700 27.56	440 17.32	12.7 0.500	12.7 0.500	192.2 9.08	105.66 71	151.30 30.99	2608 48.50	3065 57.01	57340 419.9	1.98 6.49	1.41 1.41
NZ28	700 27.56	441 17.38	14.2 0.560	14.2 0.560	211.2 9.98	116.08 78	165.82 33.96	2829 52.62	3342 62.16	62461 457.4	1.98 6.49	1.41 1.41
NZ 38	700 27.56	500 19.69	17.5 0.689	12.7 0.500	232.9 11.00	127.99 86	182.83 37.45	3809 70.84	4386 81.57	95214 697.3	2.01 6.58	1.43 1.43
NZ 40	700 27.56	501 19.73	18.7 0.735	14.0 0.551	249.1 11.77	136.91 92	195.59 40.06	4031 74.97	4664 86.75	100997 739.6	2.01 6.58	1.43 1.43
NZ 42	700 27.56	502 19.77	19.5 0.769	15.0 0.589	262.7 12.41	144.36 97	206.23 42.24	4203 78.17	4881 90.80	105490 772.5	2.01 6.58	1.43 1.43

TABLESTACAS DE ACERO LAMINADAS EN CALIENTE

NZ

NZ AVAILABLE STEEL GRADES

ASTM	LÍMITE ELÁSTICO	
	MPa	ksi
A 328	270	39
A 572 Grade 50	345	50
A 572 Grade 60	415	60
A 588	345	50
A 690	345	50

COMBINACIONES DE CANDADO

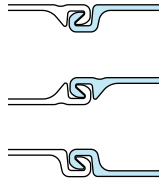

CONECTORES

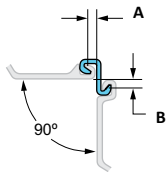

E 20
Gr: S 355 GP
Peso: 14.4 kg/m
9.68 lb/ft
A: 25 mm
~0.98"
B: 25 mm
~0.98"

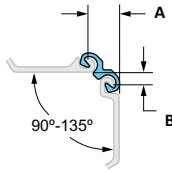

OMEGA 18
Gr: S 430 GP
Peso: 18.0 kg/m
12.10 lb/ft
A: ~70 mm
~2.76"
B: ~30 mm
~1.18"

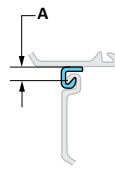

E 22
Gr: S 355 GP
Peso: 10.2 kg/m
6.87 lb/ft
A: ~30 mm
~1.18"

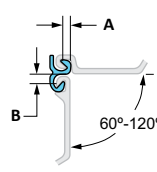

DELTA 13
Gr: S 355 GP
Peso: 13.1 kg/m
8.8 lb/ft
A: ~15 mm
~0.59"
B: ~20 mm
~0.79"

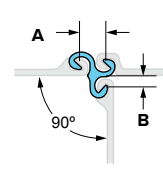

LARSEN T
Gr: A 572 Gr. 60
Peso: 20.9 kg/m
14.0 lb/ft
A: 5.27 mm
2.075"
B: 23.2 mm
0.914"

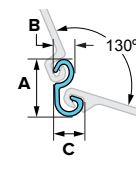

SKLC 90
Gr: A 572 Gr. 60
Peso: 12.6 kg/m
8.50 lb/ft
A: 103.9 mm
4.09"
B: 279 mm
1.10"
C: 52.1 mm
2.05"

TABLESTACA DE ESQUINA

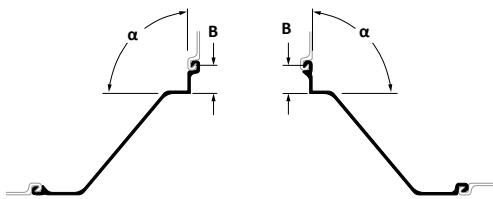

TYP01-α
α: Angle varies
B: 76.2mm- 152.4mm (3"-6")

TYP02-α
α: Angle varies
B: 76.2mm- 152.4mm (3"-6")

T PILE
α: Angle varies
B: 76.2mm- 152.4mm (3"-6")

TOLERANCIAS DE ENTREGA

	ASTM A 6
Peso	± 2.5%
Longitud	± 200 mm

LONGITUDES MÁXIMAS*

NZ	32.0 m	105.0 feet
----	--------	------------

* Es posible fabricar en longitudes mayores a pedido.

TABLESTACAS DE ACERO LAMINADAS EN FRÍO

SCZ/SKZ

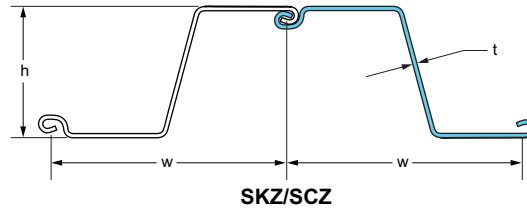

SECCIÓN	Ancho (w) mm in	Altura (h) mm in	Espesor (t) mm in	Sección transversal cm²/m in²/ft	PESO		MÓDULO DE SECCIÓN		Momento de inercia cm⁴/m in⁴/ft	ÁREA DE REVESTIMIENTO	
					Tablestaca kg/m lb/ft	Pared kg/m² lb/ft²	Elástico cm³/m in³/ft	Plástico cm³/m in³/ft		Ambos lados m²/m ft²/ft	Superficie de la pared m²/m² ft²/ft²
SCZ 12	723.9 28.50	254.0 10.00	5.1 0.200	70.3 3.32	40.20 27.01	55.51 11.37	619 11.52	704 1310	7866 57.6	1.86 6.10	1.28 1.28
SCZ 14	723.9 28.50	254.0 10.00	6.4 0.250	88.48 4.18	50.31 33.81	69.50 14.23	772 14.36	877.4 16.32	9808 71.82	1.86 6.10	1.28 1.28
SCZ 16	723.9 28.50	254.0 10.00	7.0 0.276	97.79 4.62	55.61 37.37	76.82 15.73	847 15.75	965.9 17.97	10751 78.73	1.86 6.10	1.28 1.28
SCZ 17N	723.9 28.50	254.0 10.00	7.5 0.295	104.78 4.95	59.58 40.03	82.32 16.86	907 16.87	1033 19.21	11519 84.35	1.86 6.10	1.28 1.28
SCZ 18N	723.9 28.50	254.0 10.00	8.1 0.317	112.39 5.31	63.91 42.94	88.28 18.08	973 18.10	1108 20.61	12356 90.48	1.86 6.10	1.28 1.28
SCZ 21N	723.9 28.50	254.0 10.00	9.5 0.375	133.06 6.29	75.66 50.84	104.54 21.41	1152 21.43	1312 24.40	14629 107.13	1.86 6.10	1.28 1.28
SKZ 20	723.9 28.50	406.4 16.00	8.0 0.315	127.00 6.00	71.79 48.24	99.17 20.31	1704 31.69	1970.97 36.66	34618 253.51	2.32 7.60	1.60 1.60
SKZ 22	723.9 28.50	406.4 16.00	8.5 0.335	133.35 6.30	76.34 51.30	105.46 21.60	1797 33.43	2093.55 38.94	36515 267.40	2.32 7.60	1.60 1.60
SKZ 23	723.9 28.50	406.4 16.00	9.0 0.354	141.82 6.70	80.66 54.20	111.42 22.82	1915 35.61	2210.75 41.12	38905 284.90	2.32 7.60	1.60 1.60
SKZ 24	723.9 28.50	406.4 16.00	9.5 0.375	150.28 7.10	85.47 57.43	118.06 24.18	2028 37.73	2339.78 43.52	41213 301.80	2.32 7.60	1.60 1.60
SKZ 25	723.9 28.50	406.4 16.00	10.1 0.399	160.87 7.60	90.93 61.10	125.61 25.73	2158 40.14	2486.02 46.24	43851 321.12	2.32 7.60	1.60 1.60
SKZ 31	723.9 28.50	457.2 18.00	11.4 0.450	192.04 9.07	109.85 73.82	151.75 31.08	2772 51.56	3253.29 60.51	63369 464.05	2.46 8.06	1.70 1.70
SKZ 33	723.9 28.50	457.2 18.00	12.1 0.475	198.97 9.40	115.54 77.64	159.61 32.69	2951 54.89	3417.68 63.57	67462 494.03	2.46 8.06	1.70 1.70
SKZ 34	723.9 28.50	457.2 18.00	12.7 0.500	209.25 9.89	121.17 81.42	167.38 34.28	3098 57.62	3594.60 66.86	70821 518.62	2.46 8.06	1.70 1.70
SKZ 36	723.9 28.50	457.2 18.00	13.6 0.535	228.10 10.78	129.19 86.81	178.46 36.55	3264 60.71	3848.17 71.58	74619 546.43	2.46 8.06	1.70 1.70
SKZ 38	723.9 28.50	457.2 18.00	14.0 0.550	234.42 11.07	132.37 88.95	182.85 37.45	3350 62.32	3952.44 73.52	76588 560.85	2.46 8.06	1.70 1.70

COMPATIBILIDAD DE CANDADO

	SCZ 12	SCZ 14	SCZ 16	SCZ 17N	SCZ 18N	SCZ 21N	SKZ 20	SKZ 22	SKZ 23	SKZ 24	SKZ 25	SKZ 31	SKZ 33	SKZ 34	SKZ 36	SKZ 38
SCZ 12	●	●	●	●	●	●	●	●	●	●	●	○	○	○	○	○
SCZ 14	●	●	●	●	●	●	●	●	●	●	●	○	○	○	○	○
SCZ 16	●	●	●	●	●	●	●	●	●	●	●	○	○	○	○	○
SCZ 17N	●	●	●	●	●	●	●	●	●	●	●	○	○	○	○	○
SCZ 18N	●	●	●	●	●	●	●	●	●	●	●	○	○	○	○	○
SCZ 21N	●	●	●	●	●	●	●	●	●	●	●	○	○	○	○	○
SKZ 20	●	●	●	●	●	●	●	●	●	●	●	○	○	○	○	○
SKZ 22	●	●	●	●	●	●	●	●	●	●	●	○	○	○	○	○
SKZ 23	●	●	●	●	●	●	●	●	●	●	●	○	○	○	○	○
SKZ 24	●	●	●	●	●	●	●	●	●	●	●	○	○	○	○	○
SKZ 25	●	●	●	●	●	●	●	●	●	●	●	○	○	○	○	○
SKZ 31	○	○	○	○	○	○	○	○	○	○	○	●	●	●	●	●
SKZ 33	○	○	○	○	○	○	○	○	○	○	○	●	●	●	●	●
SKZ 34	○	○	○	○	○	○	○	○	○	○	○	●	●	●	●	●
SKZ 36	○	○	○	○	○	○	○	○	○	○	○	●	●	●	●	●
SKZ 38	○	○	○	○	○	○	○	○	○	○	○	●	●	●	●	●

● Candado es compatible ○ Candado no es compatible

TABLESTACAS DE ACERO LAMINADAS EN FRÍO

SCZ/SKZ

GRADOS DE ACERO DISPONIBLES / ESPECIFICACIONES ESTADOUNIDENSE

ASTM	LÍMITE ELÁSTICO		ASTM	LÍMITE ELÁSTICO	
	MPa	ksi		MPa	ksi
A 572 Grado 50	345	50	A 588	345	50
A 572 Grado 55	380	55	A 690 Grade 50	345	50
A 572 Grado 60	415	60	A 690 Grade 60	415	60
A 572 Grado 65	450	65			

TABLESTACA DE ESQUINA

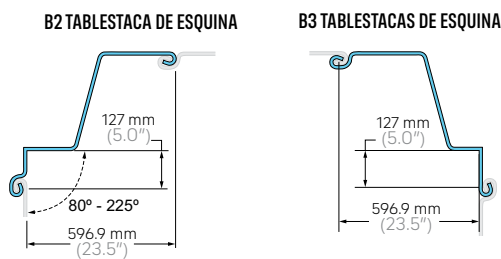

CONECTORES

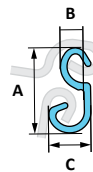

SKLC 90

Gr: A 572 Gr. 60
 Peso: 12.6 kg/m (8.50 lb/ft)
 A: 103.9 mm (4.09")
 B: 279 mm (1.10")
 C: 52.1 mm (2.05")

TOLERANCIAS DE ENTREGA

	ASTM A6	EN 10249-2		
Peso	± 2.5%	± 7%		
Longitud	+ 5"	- 0"	± 50 mm	
Pandeo (S)		0.25% de la longitud		
Arqueo (C)		0.25% de la longitud		
Torsión (V)		2% de la longitud		

LONGITUDES MÁXIMAS*

SCZ/SKZ 27.4 m 90 ft.

*Es posible fabricar en longitudes mayores a pedido.

TABLESTACAS DE ACERO LAMINADAS EN FRÍO SKL/SKS

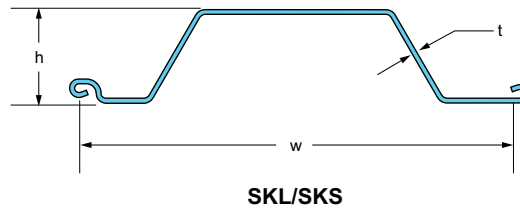

SECCIÓN	Ancho (w)	Altura (h)	Espesor (t)	Sección transversal	PESO		MÓDULO DE SECCIÓN			ÁREA DE REVESTIMIENTO	
					Tablestaca	Pared	Elástico	Plástico	Momento de inercia	Ambos lados	Superficie de la pared
					kg/m lb/ft	kg/m ² lb/ft ²	cm ³ /m in ³ /ft	cm ³ /m in ³ /ft	cm ⁴ /m in ⁴ /ft	m ² /m ft ² /ft	m ² /m ² ft ² /ft ²
SKL 9	550 21.65	90 3.54	4.0 0.157	53.50 2.53	23.10 15.52	42.00 8.60	137 2.55	176.43 3.28	615 4.50	1.29 4.23	1.17 1.17
SKL 10	550 21.65	90 3.54	4.5 0.177	59.90 2.83	25.90 17.40	47.00 9.63	155 2.88	197.23 3.67	695 5.09	1.29 4.23	1.17 1.17
SKL 12	550 21.65	90 3.54	5.5 0.217	72.60 3.43	31.40 21.10	57.00 11.67	190 3.53	237.66 4.42	850 6.22	1.29 4.23	1.17 1.17
SKS 11	700 27.56	150 5.91	5.0 0.197	69.60 3.29	38.23 25.69	55.00 11.26	341 6.34	405.36 7.54	2550 18.67	1.79 5.87	1.28 1.28
SKS 13	700 27.56	150 5.91	5.5 0.217	76.40 3.61	42.00 28.22	60.00 12.29	375 6.98	454.03 8.44	2810 20.48	1.79 5.87	1.28 1.28
SKS 14	700 27.56	150 5.91	6.4 0.250	88.20 4.17	48.49 32.58	69.27 14.19	433 8.05	509.87 9.48	3247 23.78	1.79 5.87	1.28 1.28
SKS 16	700 27.56	150 5.91	7.0 0.276	96.70 4.57	53.00 35.61	76.00 15.57	478 8.89	559.20 10.40	3585 26.25	1.79 5.87	1.28 1.28

COMPATIBILIDAD DE CANDADO

	SKL 9	SKL 10	SKL 12	SKS 11	SKS 13	SKS 14	SKS 16
SKL 9	●	●	●	●	●	●	●
SKL 10	●	●	●	●	●	●	●
SKL 12	●	●	●	●	●	●	●
SKS 11	●	●	●	●	●	●	●
SKS 13	●	●	●	●	●	●	●
SKS 14	●	●	●	●	●	●	●
SKS 16	●	●	●	●	●	●	●

● Candado es compatible ○ Candado no es compatible

TABLESTACAS DE ACERO LAMINADAS EN FRÍO SKL/SKS

GRADOS DE ACERO DISPONIBLES / ESPECIFICACIONES ESTADOUNIDENSE

ASTM	LÍMITE ELÁSTICO		ASTM	LÍMITE ELÁSTICO	
	MPa	ksi		MPa	ksi
A 572 Grado 50	345	50	A 588	345	50
A 572 Grado 55	380	55	A 690 Grado 50	345	50
A 572 Grado 60	415	60	A 690 Grado 60	415	60
A 572 Grado 65	450	65			

TABLESTACA DE ESQUINA

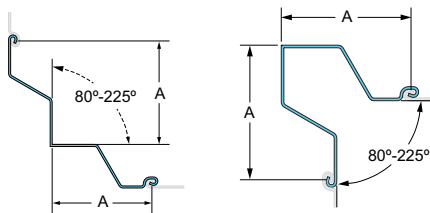

D1 TABLESTACA DE ESQUINA

D3 TABLESTACA DE ESQUINA

SKL 9-12: A: 275.0 mm
10.8 in.

SKS 11-16: A: 350.0 mm
13.8 in.

TOLERANCIAS DE ENTREGA

	ASTM A6	EN 10249-2		
Peso	± 2.5%		± 7%	
Longitud	+ 5"	- 0"	± 50 mm	
Pandeo (S)			0.25% de la longitud	
Arqueo (C)			0.25% de la longitud	
Torsión (V)			2% de la longitud	

LONGITUDES MÁXIMAS*

SKL, SKS 21.3 m 70 ft

* Es posible fabricar en longitudes mayores a pedido.

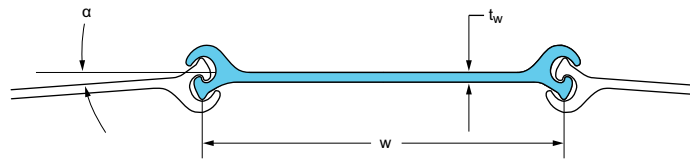

SECCIÓN	Ancho (w) mm in	Alma (tw) mm in	Máxima fuerza de enclavamiento kN/m k/in	Rotación de enclavamiento permitida (α) Grados	PESO			Módulo de sección elástica cm³/lamina in³/lamina	Momento de inercia cm⁴/m in⁴/ft	ÁREA DE REVESTIMIENTO	
					Sección transversal cm²/m in²/ft	Tablestaca kg/m lb/ft	Pared kg/m² lb/ft²			Ambos lados m²/m ft²/ft	Superficie de la pared m²/m² ft²/ft²
PS 275	500 19.69	10.2 0.4	3500 20	7.0	171.2 8.09	671 45.1	134.3 27.5	54 3.3	221 5.3	1.11 3.65	1.11 1.11
PS 31	500 19.69	12.7 0.5	3500 20	7.0	193.0 9.12	75.7 50.9	151.4 31.0	54 3.3	221 5.3	1.11 3.65	1.11 1.11

† No se puede garantizar el diámetro mínimo de la celda para pilotes de más de 65 pies (19,81 m) de largo, o si los pilotes están empalmados. Se necesitan 58 pilas para hacer una celda de 30 pies de diámetro.

Los pilotes predoblados están disponibles para lograr un radio más estrecho en las celdas y los arcos.

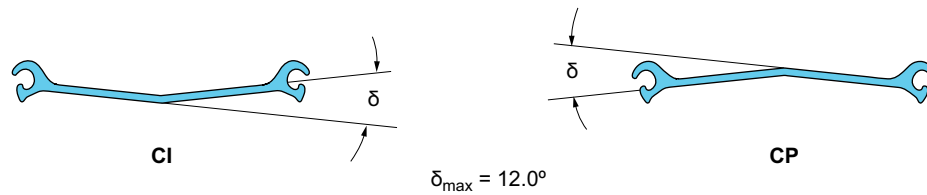

GRADOS DE ACERO DISPONIBLES / ESPECIFICACIONES ESTADOUNIDENSE

ASTM	LÍMITE ELÁSTICO	
	ksi	MPa
A328	39	270
A572 Gr 50	50	345
A588	50	345
A690	50	345

* Only available for AS 500-13.0 sheet.

PILOTES DE UNIÓN

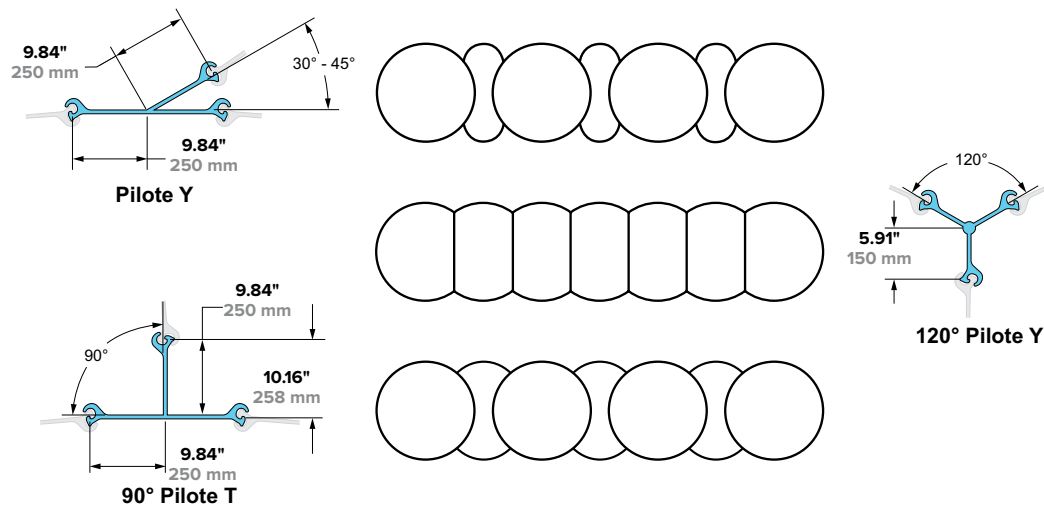

TOLERANCIAS DE ENTREGA

	ASTM A6	EN 10248
Peso	± 2.5%	± 5%
Longitud	+ 5 in. - 0 in.	± 200 mm
Altura		± 5 mm
Espesor		± 6%
Ancho		± 2%
Rectitud		0.2% de la longitud
Terminación fuera de cuadrado		2% del ancho

LONGITUDES MÁXIMAS*

PS	32.0 m	105.0 ft.
----	--------	-----------

* Es posible fabricar en longitudes mayores a pedido.

SISTEMAS DE MUROS COMBINADOS

Los sistemas de muros combinados se utilizan cuando las tablestacas regulares no son lo suficientemente fuertes para soportar las cargas requeridas. Los dos componentes principales de un sistemas de muros combinados son el pilote king y un par de tablestacas intermedias. El conector es el tercer componente y está soldado o interconectado con el pilote king y conecta a éste con la tablestaca. La tablestaca intermedia transfiere las presiones del suelo y agua a los pilotes king, que soportan la mayoría de la carga. Las tablestacas son generalmente más cortas, variando de 60% a 100% de la longitud del pilote king. A menudo, los pilotes king están diseñados para soportar las cargas verticales además de las cargas de flexión normales.

Existe una amplia variedad de soluciones que brinda al diseñador gran flexibilidad. Cada tipo de sistema tiene sus propias ventajas.

Aplicaciones de sistemas de muros combinados

Los sistemas de muros combinados proporcionan una solución ideal para aplicaciones como: muros de retención de gran capacidad con excavaciones profundas, rompeolas, ataguías profundas y otras estructuras que requieren muros de retención para resistir grandes cargas.



Detroit, MI



Miami, FL



Corpus Christi, TX

MUROS COMBINADOS DE TUBERÍAS

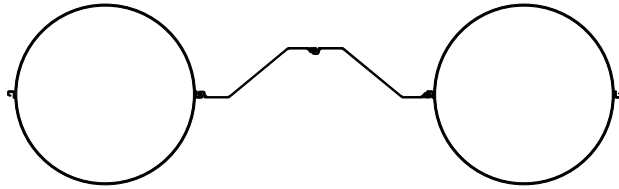

TUBERÍAS-Z CON CONECTORES E22

Beneficios del sistema

- Mejor relación entre resistencia/rigidez y costo
- Sistema más común
- No se requiere waler
- Varillas de unión/anclajes de conexión directa a la tubería

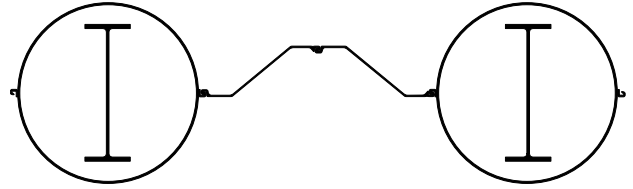

TUBERÍAS-Z WF CON CONECTORES E22

Beneficios del sistema

- Aumente la capacidad de doblado sin aumentar huella
- Casquillo de roca con conexión de cortante y momento
- No se requiere waler
- Casquillo de roca con conexión de cortante y momento

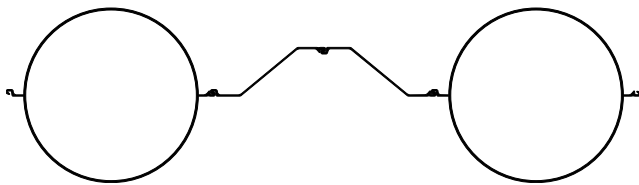

TUBERÍAS-Z CON BRIDA NZ O PZ

Beneficios del sistema

- Control preciso del ancho del sistema
- Mayor variedad de grados de acero para bridas de tablestacas
- No se requiere waler
- Varillas de unión/anclajes de conexión directa a la tubería

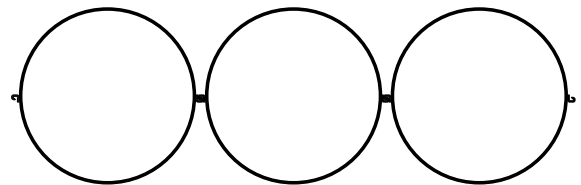

TUBERÍA-TUBERÍA CON CONECTORES E22

Beneficios del sistema

- La huella más pequeña de cualquier pared combinada de tuberías Sistema
- La capacidad más alta de cualquier sistema de pared combinado de tubería
- Un tipo de Sección para que el Contratista Conduzca

MUROS COMBINADOS DE TUBERÍAS

GRADOS DE ACERO DISPONIBLES / ESPECIFICACIONES ESTADOUNIDENSE

Especificaciones de fabricación	LÍMITE ELÁSTICO	
	ksi	MPa
A252 Grado 3 (50 ksi)	50	345
A252 Grado 3 (60 ksi)	60	415

Especificaciones de acero	LÍMITE ELÁSTICO	
	ksi	MPa
A572 Grado 60	60	415
A690	50	345

Para obtener una lista completa de grados de acero, consulte la página 66. Para conocer la disponibilidad de otros límites de rendimiento, póngase en contacto con Nucor Skyline.

TOLERANCIAS DE ENTREGA

TABLESTACAS	ASTM A6	EN10248			
Peso	± 2.5%	± 5%			
Longitud	+ 5 in.	± 200 mm			
Altura		± 7 mm			
Ancho		± 2%			
Ancho entrelazado		± 3%			
Rectitud		0.2% de la longitud			
Defectos de escuadra en las extremidades		2% del ancho			

TUBERÍAS	A139	A252	A500	A1085	AWWA C200
Diámetro exterior	± 1%	± 1%	± 0.75%	± 0.75%	+1/8" / -1/16"
Espesor	- 12.5%	- 12.5%	±10%	+10% / -5%	+10% / -5%
Weight	+10% / -5%	+10% / -5%	±10%	+10% / -3.5%	+10% / -5%
Length	± 1/2"	± 1"	+3/4" / -1/4"	+3/4" / -1/4"	± 2"

**Las diferentes condiciones y tolerancias varían según el diámetro, la longitud y los requisitos del proyecto. Por favor, pregunte para obtener información adicional.

LONGITUDES MÁXIMAS†

Tubería con soldadura helicoidal	130 ft.	39.6 m
Tuberías laminadas y soldadas	120 ft.	36.6 m
E22	59 ft.	18.0 m
NZ	105 ft.	32.0 m

† Es posible fabricar longitudes mayores a pedido.

PILOTE H

El pilote H (también conocido como HBP ó HP) es fabricado por Nucor y representa la mayoría de los pilotes de acero abastecidos por Nucor Skyline.

Por primera vez en varias décadas, Nucor expandió recientemente la gama de pilotes H. Tradicionalmente, el pilote H se hacía en los tamaños de 200mm, 250mm y 310mm. La capacidad de las secciones previas se ha casi duplicado añadiendo los nuevos rangos de pilotes de 410mm y 460mm. Al igual que el resto del acero producido, se fabrica con el horno de arco eléctrico, el pilote H está hecho 100% de chatarra y es 100% reciclable.

Aplicaciones del Pilote H

Los pilotes H se utilizan comúnmente como pilotes de cimentación y se hincan para soportar puentes, edificios, fábricas, estadios y casi todo tipo de estructuras. Los pilotes H son los más efectivos como pilotes de punta, pero también resisten cargas a través de fricción lateral.

Los pilotes H también se utilizan para largueros y como apuntalamiento en las cajas-dique, y en paredes de vigas y aislantes.



Amherst, MA



Wichita, KS



Los Angeles, CA

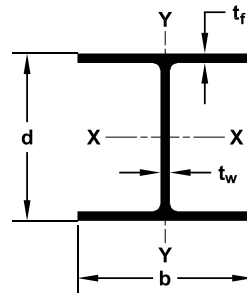

SECCIÓN	Peso kg/m lb/ft	Área cm ² in ²	Peralte (d) mm in	Ancho de patín (b) mm in	ESPESOR		Área lateral m ² /m ft ² /ft	PROPIEDADES							
					Patín (t _f) mm in	Alma (t _w) mm in		Eje X-X				Eje Y-Y			
								I cm ⁴ in ⁴	S cm ³ in ³	Z cm ³ in ³	r cm in	I cm ⁴ in ⁴	S cm ³ in ³	Z cm ³ in ³	r cm in
HP 200 HP 8	54	68.4	204	207	11.3	11.3	1.19	4953	488	550.6	8.53	1677	162	2491	4.95
	36	10.6	8.02	8.16	0.445	0.445	3.92	119	29.8	33.6	3.36	40.3	9.88	15.2	1.95
HP 250 HP 10	63	80.0	246	257	10.7	10.5	1.47	8741	711	791.5	10.5	2984	233	357.2	6.12
	42	12.4	9.70	10.10	0.420	0.415	4.83	210	43.4	48.3	4.13	71.7	14.2	21.8	2.41
	85	108	254	259	14.4	14.4	1.50	12237	964	1089.7	10.6	4204	323	496.5	6.22
	57	16.7	9.99	10.20	0.565	0.565	4.91	294	58.8	66.5	4.18	101	19.7	30.3	2.45
	79	100	300	305	11.0	11.0	1.77	16358	1093	1212.6	12.8	5286	346	527.7	7.26
	53	15.5	11.80	12.00	0.435	0.435	5.82	393	66.7	74.0	5.03	127	21.1	32.2	2.86
	94	119	302	307	13.1	13.1	1.79	19646	1296	1447.0	12.9	6368	415	634.2	7.32
	63	18.4	11.90	12.10	0.515	0.515	5.86	472	79.1	88.3	5.06	153	25.3	38.7	2.88
	110	141	307	310	15.5	15.4	1.80	23683	1537	1720.6	13.0	7742	498	763.6	7.42
	74	21.8	12.10	12.20	0.610	0.605	5.91	569	93.8	105	5.11	186	30.4	46.6	2.92
HP 310 HP 12	125	159	312	312	17.4	17.4	1.82	27055	1737	1966.4	13.1	8866	567	871.8	7.47
	84	24.6	12.30	12.30	0.685	0.685	5.97	650	106	120	5.14	213	34.6	53.2	2.94
	132	167	314	313	18.3	18.3	1.84	28700	1830	2070	13.1	9370	599	922	7.48
	89	25.9	12.36	12.32	0.720	0.720	6.04	689	111.6	126.3	5.16	225	36.5	56.2	2.94
	152	193	319	321	20.8	20.8	1.88	33800	2120	2420	13.2	11500	716	1100	7.71
	102	29.9	12.56	12.64	0.819	0.819	6.17	811	129.3	147.6	5.20	276	43.7	67.1	3.04
	174	222	324	327	23.6	23.6	1.91	39400	2430	2800	13.3	13800	843	1300	7.89
	117	34.4	12.76	12.87	0.929	0.929	6.26	946	148.2	170.8	5.24	331	51.4	79.3	3.11
	109	138	345	371	12.8	12.8	2.12	30343	1753	1933.7	14.8	10864	587	894.7	8.86
	73	21.4	13.60	14.60	0.505	0.505	6.96	729	107	118	5.84	261	35.8	54.6	3.49
HP 360 HP 14	132	168	351	373	15.6	15.6	2.14	37627	2147	2392.5	14.9	13569	726	1109.4	8.97
	89	26.1	13.80	14.70	0.615	0.615	7.02	904	131	146	5.88	326	44.3	67.7	3.53
	152	194	356	376	17.9	17.9	2.15	43704	2458	2769.4	15.0	15817	842	1291.3	9.04
	102	30.1	14.00	14.80	0.705	0.705	7.06	1050	150	169	5.92	380	51.4	78.8	3.56
	174	222	361	378	20.4	20.4	2.34	50780	2819	3179.1	15.1	18439	975	1497.8	9.12
	117	34.4	14.20	14.90	0.805	0.805	7.12	1220	172	194	5.96	443	59.5	91.4	3.59
	131	167	389	399	13.7	13.7	2.29	46201	2376	2638.3	16.7	14526	729	1117.6	9.35
	88	25.8	15.30	15.70	0.540	0.540	7.52	1110	145	161	6.56	349	44.5	68.2	3.68
	150	193	394	401	15.9	15.9	2.30	54110	2753	3064.4	16.7	17149	855	1312.6	9.42
	101	29.9	15.50	15.80	0.625	0.625	7.56	1300	168	187	6.59	412	52.2	80.1	3.71
HP 410 HP 16	180	231	401	404	19.1	19.1	2.32	66180	3294	3703.5	16.9	20978	1039	1599.4	9.53
	121	35.8	15.80	15.90	0.750	0.750	7.62	1590	201	226	6.66	504	63.4	97.6	3.75
	210	269	406	406	22.2	22.2	2.34	77835	3835	4326.2	17.0	24932	1227	1900.9	9.63
	141	41.7	16.00	16.00	0.875	0.875	7.69	1870	234	264	6.70	599	74.9	116	3.79
	241	308	414	409	25.4	25.4	2.36	91154	4408	5014.4	17.2	29011	1419	2195.9	9.70
	162	47.7	16.30	16.10	1.000	1.000	7.75	2190	269	306	6.78	697	86.6	134	3.82
	272	349	419	414	28.7	28.7	2.38	104473	4982	5719.1	17.3	34047	1639	2556.4	9.88
	183	54.1	16.50	16.30	1.130	1.130	7.81	2510	304	349	6.81	818	100.0	156	3.89
	201	257	445	452	19.1	19.1	2.60	91570	4113	4604.7	18.9	29386	1299	1999.2	10.7
	135	39.9	17.50	17.80	0.750	0.750	8.54	2200	251	281	7.43	706	79.3	122	4.21
HP 460 HP 18	234	298	450	455	22.1	22.1	2.62	106971	4752	5358.5	18.9	34672	1526	2343.3	10.8
	157	46.2	17.70	17.90	0.870	0.870	8.60	2570	290	327	7.46	833	93.1	143	4.25
	269	343	457	457	25.4	25.4	2.64	125701	5506	6210.7	19.1	40541	1770	2736.6	10.9
	181	53.2	18.00	18.00	1.000	1.000	8.66	3020	336	379	7.53	974	108.0	167	4.28
	304	388	465	460	28.7	28.7	2.66	144847	6227	7095.6	19.3	46618	2032	3129.9	11.0
	204	60.2	18.30	18.10	1.130	1.130	8.73	3480	380	433	7.60	1120	124.0	191	4.31

GRADOS DE ACERO DISPONIBLES / ESPECIFICACIONES ESTADOUNIDENSE

ESTADOUNIDENSE			CANADIENSE		
ASTM	LÍMITE ELÁSTICO		CSA 640.21	LÍMITE ELÁSTICO	
	(MPa)	(ksi)		(MPa)	(ksi)
A 36	250	36	Grado 300 W	300	45
A 572 Grado 50*	345	50	Grado 350 W	350	50
A 572 Grado 60	415	60			
A 588	345	50			
A 690	345	50			
A 709	345	50			
A 913*	415	60			
A 913*	450	65			

* Disponible para HP12x89 y mayores.

EMPALMADORA Y ZAPATA DE CORTE



Empalmadora

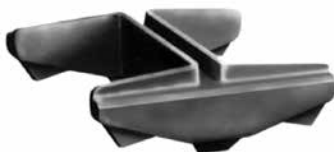

Zapata de Corte

TOLERANCIAS DE ENTREGA

ASTM A 6		
Peso	± 2.5%	
Longitud		
30 Pies y Menos	± 9.52mm	
Más de 30 pies	25.4"/mm((3.75" + (Longitud - 30)/80))	- 9.52mm
Peralte	± 3.17mm	- 4.76mm
Ancho de patín	+ 6.35mm	
Bridas descuadradas		
HP 200 x 42 - HP 310 x 84	≤ 6.35mm	
HP 360 x 73 - HP 360 x 117	≤ 7.94mm	
Unión descentrada	≤ 4.76mm	
Peralte máxima sobre teóricos	≤ 6.35mm	
La inclinación y barrido***		
45 Pies y Menos	25.4"/mm((0.125")(Longitud en pie/10) pero no más que 0.375")	
Más de 45 pies	25.4"/mm((.375") + (1.25" (Longitud en pies - 45)/10))	

Para los HP que se ordenen como pilotes de carga, las tolerancias de la longitud son +127mm. y -0 mm.

*** Para el HP 250 x 42, 310 x 53, 310 x 63, 360 x 72, y 360 x 89, las tolerancias están sujetas a negociación con el fabricante.

LONGITUDES MÁXIMAS†

HPs	30.5m	100 ft
-----	-------	--------

† Es posible fabricar longitudes mayores a pedido.

TUBERÍAS

Nucor Skyline produce tres tipos de tubería: con soldadura longitudinal, con soldadura helicoidal y laminados-soldados. Todas las tuberías son hechas con acero que tiene propiedades físicas y químicas similares. Todos estos tipos de tubería se sueldan usando bobina con penetración completa que son tan fuertes como el material base.

Tubería de costura recta (ERW)

La tubería ERW es hecha de bobina de acero y la soldadura corre paralela a la tubería. El ancho de la bobina es igual a la circunferencia de la tubería, limitando los diámetros a 24 pulgadas. Sin embargo, el proceso de fabricación es rápido y es ideal para producción grande de secciones de diámetros pequeños (≤ 24 pulg.).

Tubería con soldadura helicoidal

La tubería con soldadura helicoidal, como la tubería ERW, es producida usando bobina de acero. La diferencia es que la bobina es colocada en un ángulo, haciendo que la soldadura corra al exterior de la tubería en forma de una hélice. Esto permite mucha más variación en el diámetro y espesor que la tubería ERW. La tubería con soldadura helicoidal es usada comúnmente para diámetros entre 24 pulgadas y 120 pulgadas y espesores de 1.0 pulgadas o menos.

Tuberías laminadas y soldadas

La tubería laminada y soldada es producida usando secciones de placas las cuales se juntan para formar anillos. La junta del anillo es soldada y después cada anillo individual es soldado con los demás para hacer el tubo final. La tubería laminada y soldada puede ser producida en diámetros de hasta 16 pies y más de 2.0 pulgadas de espesor.

La tubería es ideal para pilotes de carga ya que puede ser producida en una amplia variedad de tamaños, grados y longitudes. También es fácil de empalme y se puede hincar en dos formas: abierto o cerrado. La tubería cerrada se puede llenar con concreto para aumentar la capacidad total después de que ha sido hincada. La Sociedad Estadounidense de Ingenieros Civiles (ASCE) recomienda un factor de seguridad menor para la tubería cerrada, rellena con concreto, que cualquier otro tipo de pilotes de cimentación (hincados o colados in situ) debido principalmente a lo predecible por la homogeneidad del producto instalado. La tubería también se puede usar para:

- Muros combinados de Tuberías-Z
- Señalamientos
- Cubierta para campanas neumáticas
- Empuje de tubería mediante gateo hidráulico
- Refuerzo para ataguías o ayuda de la excavación
- Tanques
- Ejes de mina
- Líneas de transmisión



Seattle, WA



Los Angeles, CA



Camden, NJ

PROPIEDADES DE LA TUBERÍA

El ejemplo es una tubería de 610 mm x 12.7 mm

Diámetro exterior	Espesor de pared	Peso	Diámetro interno	Sección transversal	Área total del eje	Área interna	Volumen interno	Área de revestimiento	Momento de inercia	Módulo de Sección	Radio de giro
mm in	mm in	kg/m lb/ft	mm in	cm ² in ²	cm ² in ²	cm ² in ²	m ³ /m ft ³ /ft	m ² /m ft ² /ft	cm ⁴ in ⁴	cm ³ in ³	cm in
610 24	12.700 0.500	186.9 125.6	584.2 23.00	238.2 36.91	2,919 452.4	2,680 415.5	0.268 2.885	1.92 6.28	106,100 2,549	3,481 212.4	21.11 8.31

DIMENSIONES

Diámetro exterior	:	D_o	=	610 mm
Espesor de pared	:	t	=	12.7 mm
Diámetro interno	:	$D_i = D_o - 2 \times t$	=	584.2 mm
Peso de tubería	:	$w_{tubería} = A_s \times 10^{-4} \times 7850 \text{ kg/m}^3$	=	186.9 kg/m

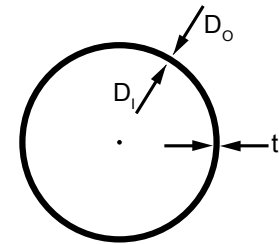

PROPIEDADES DE INGENIERÍA

Sección transversal	:	$A_s = \frac{\pi (D_o^2 - D_i^2)}{4} \times 10^{-2}$	=	238.2 cm ²
Área total del pilote	:	$A_t = \pi (D_o/2)^2 \times 10^{-2}$	=	2,919 cm ²
Volumen interno	:	$V_{internal} = \pi (D_i/2)^2 \times 10^{-6} \times 1\text{m/m}$	=	0.268 m ³ /m
Área de revestimiento	:	$A_{coat} = (\pi \times D_o) \times 10^{-3} \times 1\text{m/m}$	=	1.92 m ² /m
Momento de inercia	:	$I = \frac{\pi (D_o^4 - D_i^4)}{64} \times 10^{-4}$	=	106,100 cm ⁴
Módulo de Sección	:	$S = \frac{I}{D_o/2} \times 10$	=	3,481 cm ³
Radio de giro	:	$r = \frac{\sqrt{D_o^2 + D_i^2}}{4} \times 10^{-1}$	=	21.11 cm

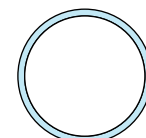

SECCIÓN TRANSVERSAL

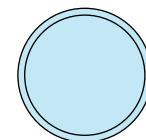

ÁREA TOTAL DEL PILOTE

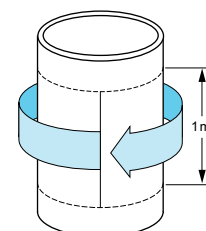

ÁREA DE REVESTIMIENTO

TUBERÍA

Diámetro exterior in mm	Espesor de pared in mm	Peso lb/ft kg/m	Diámetro interno in mm	Sección transversal in² cm²	Área total del eje in² cm²	Área interna in² cm²	Volumen interno ft³/ft m³/m	Área de revestimiento ft²/ft m²/m	Momento de inercia in⁴ cm⁴	Módulo de Sección in³ cm³	Radio de giro in cm	Rendimiento máximo disponible fuerza de A252		
												ERW	SH	L y S
												ksi (MPa)		
2 ½ 60	0.109 2.769	2.64 3.93	2.16 54.79	0.78 5.01	4.43 28.58	3.65 23.58	0.0254 0.0024	0.62 0.19	0.50 20.78	0.42 6.89	1.80 4.56	65 448	No Disponible	No Disponible
	0.154 3.912	3.66 5.44	2.07 52.50	1.08 6.93	4.43 28.58	3.36 21.65	0.0233 0.0022	0.62 0.19	0.67 27.71	0.56 9.19	1.78 4.51			
	0.188 4.775	4.40 6.54	2.00 50.77	1.29 8.33	4.43 28.58	3.14 20.25	0.0218 0.0020	0.62 0.19	0.78 32.38	0.66 10.74	1.76 4.47			
	0.218 5.537	5.03 7.48	1.94 49.25	1.48 9.53	4.43 28.58	2.95 19.05	0.0205 0.0019	0.62 0.19	0.87 36.13	0.73 11.98	1.75 4.43			
2 ¾ 73	0.120 3.048	3.53 5.26	2.64 66.93	1.04 6.70	6.49 41.88	5.45 35.18	0.0379 0.0035	0.75 0.23	0.99 41.09	0.69 11.25	1.84 4.66	60 414	No Disponible	No Disponible
	0.188 4.775	5.40 8.04	2.50 63.47	1.59 10.24	6.49 41.88	4.91 31.64	0.0341 0.0032	0.75 0.23	1.44 59.91	1.00 16.41	1.81 4.59			
	0.203 5.156	5.80 8.63	2.47 62.71	1.70 10.99	6.49 41.88	4.79 30.89	0.0332 0.0031	0.75 0.23	1.53 63.66	1.06 17.44	1.80 4.57			
	0.219 5.563	6.22 9.25	2.44 61.90	1.83 11.79	6.49 41.88	4.66 30.09	0.0324 0.0030	0.75 0.23	1.62 67.53	1.13 18.49	1.79 4.55			
	0.276 7.010	7.67 11.41	2.32 59.00	2.25 14.54	6.49 41.88	4.24 27.34	0.0294 0.0027	0.75 0.23	1.92 80.09	1.34 21.94	1.77 4.48			
3 ½ 89	0.120 3.048	4.34 6.45	3.26 82.80	1.27 8.22	9.62 62.07	8.35 53.85	0.0580 0.0054	0.92 0.28	1.82 75.84	1.04 17.06	1.90 4.83	60 414	No Disponible	No Disponible
	0.188 4.775	6.66 9.91	3.12 79.35	1.96 12.62	9.62 62.07	7.67 49.45	0.0532 0.0049	0.92 0.28	2.69 112.0	1.54 25.20	1.87 4.76			
	0.203 5.156	7.16 10.65	3.09 78.59	2.10 13.57	9.62 62.07	7.52 48.51	0.0522 0.0049	0.92 0.28	2.87 119.4	1.64 26.85	1.87 4.74			
	0.219 5.563	7.68 11.43	3.06 77.77	2.26 14.56	9.62 62.07	7.36 47.51	0.0511 0.0048	0.92 0.28	3.05 127.0	1.74 28.57	1.86 4.72			
	0.276 7.010	9.51 14.16	2.95 74.88	2.80 18.04	9.62 62.07	6.83 44.04	0.0474 0.0044	0.92 0.28	3.66 152.3	2.09 34.26	1.83 4.66			
4 ½ 114	0.120 3.048	5.62 8.36	4.26 108.2	1.65 10.65	15.90 102.6	14.25 91.96	0.0990 0.0092	1.18 0.36	3.96 164.9	1.76 28.86	2.03 5.16	60 414	No Disponible	No Disponible
	0.188 4.775	8.67 12.90	4.12 104.7	2.55 16.43	15.90 102.6	13.36 86.18	0.0928 0.0086	1.18 0.36	5.93 246.8	2.64 43.19	2.00 5.09			
	0.237 6.020	10.80 16.07	4.03 102.3	3.17 20.48	15.90 102.6	12.73 82.13	0.0884 0.0082	1.18 0.36	7.23 301.0	3.21 52.68	1.98 5.03			
	0.337 8.560	15.00 22.32	3.83 97.18	4.41 28.44	15.90 102.6	11.50 74.17	0.0798 0.0074	1.18 0.36	9.61 400.0	4.27 69.99	1.94 4.93			
	0.375 9.525	16.54 24.61	3.75 95.25	4.86 31.35	15.90 102.6	11.04 71.26	0.0767 0.0071	1.18 0.36	10.42 433.8	4.63 75.90	1.93 4.89			
6 ¾ 168	0.188 4.775	12.94 19.25	6.25 158.7	3.80 24.53	34.47 222.4	30.67 197.9	0.2130 0.0198	1.73 0.53	19.71 820.3	6.0 97.50	2.28 5.78	60 414	No Disponible	No Disponible
	0.280 7.112	18.99 28.26	6.07 154.1	5.58 36.01	34.47 222.4	28.89 186.4	0.2006 0.0186	1.73 0.53	28.14 1,171	8.5 139.2	2.25 5.70			
	0.375 9.525	25.06 37.28	5.88 149.2	7.36 47.50	34.47 222.4	27.11 174.9	0.1883 0.0175	1.73 0.53	36.08 1,502	10.89 178.5	2.21 5.62			
	0.432 10.973	28.60 42.56	5.76 146.3	8.41 54.23	34.47 222.4	26.07 168.2	0.1810 0.0168	1.73 0.53	40.49 1,685	12.2 200.3	2.20 5.58			
	0.500 12.700	32.74 48.72	5.63 142.9	9.62 62.07	34.47 222.4	24.85 160.3	0.1726 0.0160	1.73 0.53	45.42 1,890	13.71 224.7	2.17 5.52			
	0.562 14.275	36.43 54.20	5.50 139.7	10.70 69.06	34.47 222.4	23.77 153.3	0.1650 0.0153	1.73 0.53	49.61 2,065	14.98 245.4	2.15 5.47			

Diámetro exterior in mm	Espesor de pared in mm	Peso lb/ft kg/m	Diámetro interno in mm	Sección transversal in ² cm ²	Área total del eje in ² cm ²	Área interna in ² cm ²	Volumen interno ft ³ /ft m ³ /m	Área de revestimiento ft ² /ft m ² /m	Momento de inercia in ⁴ cm ⁴	Módulo de Sección in ³ cm ³	Radio de giro in cm	Rendimiento máximo disponible fuerza de A252		
												ERW	SH	L y S
												ksi (MPa)		
7 178	0.250 6.350	18.04 26.84	6.50 165.1	5.30 34.20	38.48 248.3	3318 214.1	0.2304 0.0214	1.83 0.56	30.23 1,258	8.6 141.6	2.39 6.07	65 448	No Disponible	No Disponible
	0.312 7.925	22.31 33.19	6.38 162.0	6.56 42.29	38.48 248.3	31.93 206.0	0.2217 0.0206	1.83 0.56	36.73 1,529	10.49 172.0	2.37 6.01	65 448	No Disponible	No Disponible
	0.375 9.525	26.56 39.52	6.25 158.8	7.81 50.35	38.48 248.3	30.68 197.9	0.2131 0.0198	1.83 0.56	42.96 1788.0	12.27 201.1	2.35 5.96	65 448	No Disponible	No Disponible
	0.500 12.700	34.74 51.70	6.00 152.4	10.21 65.87	38.48 248.3	28.27 182.4	0.1963 0.0182	1.83 0.56	54.24 2,258	15.50 254.0	2.31 5.85	65 448	No Disponible	No Disponible
	0.562 14.275	38.68 57.56	5.88 149.3	11.37 73.33	38.48 248.3	27.12 175.0	0.1883 0.0175	1.83 0.56	59.34 2,470	16.95 277.8	2.29 5.80	65 448	No Disponible	No Disponible
8 219	0.188 4.775	16.96 25.23	8.25 209.5	4.98 32.15	58.43 376.9	53.44 344.8	0.3711 0.0345	2.26 0.69	44.36 1,846	10.29 168.6	2.98 7.58	70 483	No Disponible	No Disponible
	0.250 6.350	22.38 33.31	8.13 206.4	6.58 42.44	58.43 376.9	51.85 334.5	0.3601 0.0335	2.26 0.69	57.72 2,403	13.38 219.3	2.96 7.52	70 483	No Disponible	No Disponible
	0.322 8.179	28.58 42.53	7.98 202.7	8.40 54.19	58.43 376.9	50.03 322.8	0.3474 0.0323	2.26 0.69	72.49 3,017	16.81 275.5	2.94 7.46	70 483	No Disponible	No Disponible
	0.375 9.525	33.07 49.22	7.88 200.0	9.72 62.71	58.43 376.9	48.71 314.2	0.3382 0.0314	2.26 0.69	82.86 3,449	19.21 314.9	2.92 7.42	70 483	No Disponible	No Disponible
	0.500 12.700	43.43 64.63	7.63 193.7	12.76 82.34	58.43 376.9	45.66 294.6	0.3171 0.0295	2.26 0.69	105.7 4,400	24.51 401.7	2.88 7.31	70 483	No Disponible	No Disponible
	0.533 13.538	46.11 68.61	7.56 192.0	13.55 87.42	58.43 376.9	44.88 289.5	0.3116 0.0290	2.26 0.69	111.4 4,636	25.83 423.3	2.87 7.28	70 483	No Disponible	No Disponible
	0.625 15.875	53.45 79.54	7.38 187.3	15.71 101.3	58.43 376.9	42.72 275.6	0.2967 0.0276	2.26 0.69	126.4 5,262	29.32 480.4	2.84 7.21	65 448	No Disponible	No Disponible
9 244	0.250 6.350	25.06 37.28	9.13 231.8	7.36 47.50	72.76 469.4	65.40 421.9	0.4541 0.0422	2.52 0.77	81.95 3,369	16.82 275.6	3.32 8.42	70 483	No Disponible	No Disponible
	0.312 7.925	31.06 46.22	9.00 228.6	9.13 58.89	72.76 469.4	63.63 410.52	0.4419 0.0411	2.52 0.77	99.08 4,124	20.59 337.4	3.29 8.37	70 483	No Disponible	No Disponible
	0.375 9.525	37.08 55.18	8.88 225.4	10.90 70.31	72.76 469.4	61.86 399.1	0.4296 0.0399	2.52 0.77	116.7 4,859	24.26 397.5	3.27 8.31	70 483	No Disponible	No Disponible
	0.500 12.700	48.77 72.58	8.63 219.1	14.33 92.47	72.76 469.4	58.43 376.9	0.4057 0.0377	2.52 0.77	149.6 6,228	31.09 509.5	3.23 8.21	80 552	No Disponible	No Disponible
	0.545 13.843	52.90 78.72	8.54 216.8	15.55 100.3	72.76 469.4	57.21 369.1	0.3973 0.0369	2.52 0.77	160.8 6,693	33.41 547.5	3.22 8.17	85 586	No Disponible	No Disponible
10 273	0.250 6.350	28.06 41.76	10.25 260.4	8.25 53.20	90.76 585.6	82.52 532.4	0.5730 0.0532	2.81 0.86	113.7 4,733	21.16 346.7	3.71 9.43	65 448	No Disponible	No Disponible
	0.312 7.925	34.81 51.81	10.13 257.2	10.23 66.01	90.76 585.6	80.53 519.6	0.5592 0.0520	2.81 0.86	139.5 5,805	25.95 425.2	3.69 9.38	65 448	No Disponible	No Disponible
	0.375 9.525	41.59 61.89	10.00 254.0	12.22 78.86	90.76 585.6	78.54 506.7	0.5454 0.0507	2.81 0.86	164.7 6,854	30.64 502.0	3.67 9.32	65 448	No Disponible	No Disponible
	0.500 12.700	54.79 81.53	9.75 247.7	16.10 103.9	90.76 585.6	74.66 481.7	0.5185 0.0482	2.81 0.86	212.0 8,822	39.43 646.2	3.63 9.22	65 448	No Disponible	No Disponible
	0.593 15.062	64.39 95.82	9.56 242.9	18.92 122.1	90.76 585.6	71.84 463.5	0.4989 0.0463	2.81 0.86	244.8 10,190	45.55 746.5	3.60 9.14	65 448	No Disponible	No Disponible
12 305	0.250 6.350	31.40 46.73	11.50 292.1	9.23 59.54	113.1 729.7	103.9 670.1	0.7213 0.0670	3.14 0.96	159.3 6,632	26.56 435.2	4.16 10.55	60 414	No Disponible	No Disponible
	0.312 7.925	38.98 58.01	11.38 289.0	11.46 73.91	113.1 729.7	101.6 655.7	0.7058 0.0656	3.14 0.96	195.8 8,149	32.63 534.7	4.13 10.50	60 414	No Disponible	No Disponible
	0.335 8.509	41.77 62.16	11.33 287.8	12.28 79.20	113.1 729.7	100.8 650.5	0.7001 0.0650	3.14 0.96	209.0 8,699	34.83 570.8	4.13 10.48	60 414	No Disponible	No Disponible
	0.375 9.525	46.60 69.35	11.25 285.8	13.70 88.36	113.1 729.7	99.40 641.3	0.6903 0.0641	3.14 0.96	231.6 9,640	38.60 632.5	4.11 10.44	60 414	No Disponible	No Disponible
	0.500 12.700	61.47 91.47	11.00 279.4	18.06 116.5	113.1 729.7	95.03 613.1	0.6600 0.0613	3.14 0.96	299.2 12,450	49.86 817.1	4.07 10.34	60 414	No Disponible	No Disponible
	0.625 15.875	76.00 113.1	10.75 273.1	22.33 144.1	113.1 729.7	90.76 585.6	0.6303 0.0586	3.14 0.96	362.3 15,080	60.39 989.6	4.03 10.23	60 414	No Disponible	No Disponible

TUBERÍA

Diámetro exterior in mm	Espesor de pared in mm	Peso lb/ft kg/m	Diámetro interno in mm	Sección transversal in ² cm ²	Área total del eje in ² cm ²	Área interna in ² cm ²	Volumen interno ft ³ /ft m ³ /m	Área de revestimiento ft ² /ft m ² /m	Momento de inercia in ⁴ cm ⁴	Módulo de Sección in ³ cm ³	Radio de giro in cm	Rendimiento máximo disponible fuerza de A252		
												ERW	SH	L y S
												ksi (MPa)		
12 ¼ 324	0.250 6.350	33.41 49.71	12.25 311.2	9.82 63.34	1277 823.7	1179 760.4	0.819 0.076	3.34 1.02	191.8 7984	30.09 4931	4.42 11.23	70 483	No Disponible	No Disponible
	0.312 7.925	41.48 61.73	12.13 308.0	12.19 78.65	1277 823.7	115.5 745.1	0.802 0.075	3.34 1.02	235.9 9.819	37.00 606.4	4.40 11.17	70 483	No Disponible	No Disponible
	0.375 9.525	49.61 73.82	12.00 304.8	14.58 94.06	1277 823.7	113.1 729.7	0.785 0.073	3.34 1.02	279.3 11,630	43.82 718.0	4.38 11.12	70 483	No Disponible	No Disponible
	0.394 10.008	52.04 77.44	11.96 303.8	15.29 98.67	1277 823.7	112.4 725.0	0.780 0.073	3.34 1.02	292.2 12,161	45.83 751.0	4.37 11.10	70 483	No Disponible	No Disponible
	0.406 10.312	53.58 79.73	11.94 303.2	15.74 101.6	1277 823.7	111.9 722.1	0.777 0.072	3.34 1.02	300.2 12,500	47.09 771.7	4.37 11.09	70 483	No Disponible	No Disponible
	0.500 12.700	65.48 97.44	11.75 298.5	19.24 124.1	1277 823.7	108.4 699.6	0.753 0.070	3.34 1.02	361.5 15,050	56.7 929.4	4.34 11.01	70 483	No Disponible	No Disponible
	0.525 13.335	68.61 102.1	11.70 297.2	20.16 130.1	1277 823.7	107.5 693.6	0.747 0.069	3.34 1.02	377.4 15,710	59.20 970.0	4.33 10.99	70 483	No Disponible	No Disponible
	0.687 17.450	88.59 131.8	11.38 289.0	26.04 168.0	1277 823.7	101.6 655.7	0.706 0.066	3.34 1.02	475.1 19,780	74.53 1,221	4.27 10.85	70 483	No Disponible	No Disponible
14 356	0.219 5.563	32.26 48.01	13.56 344.5	9.48 61.17	153.9 993.1	144.5 932.0	1.003 0.093	3.67 1.12	225.1 9,371	32.16 527.1	4.87 12.38	70 483	No Disponible	No Disponible
	0.250 6.350	36.75 54.68	13.50 342.9	10.80 69.67	153.9 993.1	143.1 923.5	0.994 0.092	3.67 1.12	255.3 10,630	36.47 597.7	4.86 12.35	70 483	No Disponible	No Disponible
	0.312 7.925	45.65 67.94	13.38 339.8	13.42 86.56	153.9 993.1	140.5 906.6	0.976 0.091	3.67 1.12	314.4 13,090	44.91 736.0	4.84 12.30	70 483	No Disponible	No Disponible
	0.375 9.525	54.62 81.28	13.25 336.6	16.05 103.6	153.9 993.1	137.9 889.6	0.958 0.089	3.67 1.12	372.8 15,520	53.25 872.6	4.82 12.24	70 483	No Disponible	No Disponible
	0.438 11.125	63.50 94.50	13.12 333.3	18.66 120.4	153.9 993.1	135.3 872.7	0.939 0.087	3.67 1.12	429.5 17,880	61.36 1,005	4.80 12.19	70 483	No Disponible	No Disponible
	0.500 12.700	72.16 107.4	13.00 330.2	21.21 136.8	153.9 993.1	132.7 856.3	0.922 0.086	3.67 1.12	483.8 20,140	69.11 1,132	4.78 12.13	70 483	No Disponible	No Disponible
	0.625 15.875	89.36 133.0	12.75 323.9	26.26 169.4	153.9 993.1	127.7 823.7	0.887 0.082	3.67 1.12	588.5 24,500	84.08 1,377	4.73 12.02	70 483	No Disponible	No Disponible
16 406	0.250 6.350	42.09 62.64	15.50 393.7	12.37 79.81	201.1 1,297	188.7 1,217	1.310 0.122	4.19 1.28	383.7 15,970	47.96 785.9	5.57 14.15	70 483	60 414	No Disponible
	0.312 7.925	52.32 77.86	15.38 390.6	15.38 99.21	201.1 1,297	185.7 1,198	1.289 0.120	4.19 1.28	473.2 19,700	59.16 969.4	5.55 14.09	70 483	60 414	No Disponible
	0.375 9.525	62.64 93.21	15.25 387.4	18.41 118.8	201.1 1,297	182.7 1,178	1.268 0.118	4.19 1.28	562.1 23,400	70.26 1,151	5.53 14.04	70 483	60 414	No Disponible
	0.406 10.312	67.68 100.7	15.19 385.8	19.89 128.3	201.1 1,297	181.2 1,169	1.258 0.117	4.19 1.28	605.0 25,180	75.62 1,239	5.52 14.01	70 483	60 414	No Disponible
	0.500 12.700	82.85 123.3	15.00 381.0	24.35 157.1	201.1 1,297	176.7 1,140	1.227 0.114	4.19 1.28	731.9 30,470	91.49 1,499	5.48 13.93	70 483	60 414	No Disponible
	0.625 15.875	102.7 152.9	14.75 374.7	30.19 194.8	201.1 1,297	170.9 1,102	1.187 0.110	4.19 1.28	893.5 37,190	111.7 1,830	5.44 13.82	70 483	60 414	No Disponible
18 457	0.250 6.350	47.44 70.59	17.50 444.5	13.94 89.94	254.5 1,642	240.5 1,552	1.670 0.155	4.71 1.44	549.1 22,860	61.02 999.9	6.28 15.94	60 414	60 414	No Disponible
	0.312 7.925	59.00 87.79	17.38 441.4	17.34 111.9	254.5 1,642	237.1 1,530	1.647 0.153	4.71 1.44	678.2 28,230	75.36 1,235	6.25 15.89	60 414	60 414	No Disponible
	0.375 9.525	70.66 105.1	17.25 438.2	20.76 134.0	254.5 1,642	233.71 1,508	1.623 0.151	4.71 1.44	806.6 33,570	89.63 1,469	6.23 15.83	60 414	60 414	No Disponible
	0.500 12.700	93.54 139.2	17.00 431.8	27.49 177.3	254.5 1,642	227.0 1,464	1.576 0.146	4.71 1.44	1,053 43,840	117.0 1,918	6.19 15.72	60 414	60 414	No Disponible
	0.625 15.875	116.1 172.8	16.75 425.5	34.12 220.1	254.5 1,642	220.4 1,422	1.530 0.142	4.71 1.44	1,289 53,660	143.2 2,347	6.15 15.61	No Disponible	60 414	No Disponible

Diámetro exterior in mm	Espesor de pared in mm	Peso lb/ft kg/m	Diámetro interno in mm	Sección transversal in ² cm ²	Área total del eje in ² cm ²	Área interna in ² cm ²	Volumen interno ft ³ /ft m ³ /m	Área de revestimiento ft ² /ft m ² /m	Momento de inercia in ⁴ cm ⁴	Módulo de Sección in ³ cm ³	Radio de giro in cm	Rendimiento máximo disponible fuerza de A252		
												ERW	SH	L y S
												ksi (MPa)		
20 508	0.312 7925	65.67 9772	19.38 492.2	19.30 124.5	314.2 2,027	294.9 1,902	2.048 0.190	5.24 1.60	935.3 38,930	93.5 1,533	6.96 17.68	60 414	60 414	No Disponible
	0.375 9.525	78.67 1171	19.25 489.0	23.12 149.2	314.2 2,027	291.0 1,878	2.021 0.188	5.24 1.60	1,113 46,350	111.3 1,825	6.94 17.63	60 414	60 414	
	0.500 12.700	104.2 155.1	19.00 482.6	30.63 197.6	314.2 2,027	283.5 1,829	1.969 0.183	5.24 1.60	1,457 60,640	145.7 2,387	6.90 17.52	60 414	60 414	
	0.625 15.875	129.5 192.6	18.75 476.3	38.04 245.4	314.2 2,027	276.1 1,781	1.917 0.178	5.24 1.60	1,787 74,380	178.7 2,928	6.85 17.41	60 414	60 414	
24 610	0.312 7925	79.01 117.6	23.38 593.8	23.22 149.8	452.4 2,919	429.2 2,769	2.980 0.277	6.28 1.92	1,629 67,800	135.7 2,224	8.38 21.27	60 414	60 414	No Disponible
	0.375 9.525	94.71 140.9	23.25 590.6	27.83 179.6	452.4 2,919	424.6 2,739	2.948 0.274	6.28 1.92	1,942 80,840	161.9 2,652	8.35 21.22	60 414	60 414	
	0.500 12.700	125.6 186.9	23.00 584.2	36.91 238.2	452.4 2,919	415.5 2,680	2.885 0.268	6.28 1.92	2,549 106,100	212.4 3,481	8.31 21.11	60 414	60 414	
	0.625 15.875	156.2 232.4	22.75 577.9	45.90 296.11	452.4 2,919	406.5 2,623	2.823 0.262	6.28 1.92	3,137 130,600	261.4 4,284	8.27 21.00	60 414	60 414	
	0.750 19.050	186.4 277.4	22.50 571.5	54.78 353.4	452.4 2,919	397.6 2,565	2.761 0.257	6.28 1.92	3,705 154,200	308.8 5,060	8.22 20.89	No Disponible	50 345	
	0.875 22.225	216.3 321.9	22.25 565.2	63.57 410.1	452.4 2,919	388.8 2,509	2.700 0.251	6.28 1.92	4,255 177,100	354.6 5,811	8.18 20.78	No Disponible	50 345	
	1.000 25.400	245.9 365.9	22.00 558.8	72.26 466.2	452.4 2,919	380.1 2,452	2.640 0.245	6.28 1.92	4,787 199,300	398.9 6,537	8.14 20.67	No Disponible	50 345	
30 762	0.312 7925	99.02 147.3	29.38 746.2	29.10 187.7	706.9 4,560	677.8 4,373	4.71 0.44	7.85 2.39	3,206 133,500	213.8 3,503	10.50 26.66	No Disponible	60 414	No Disponible
	0.375 9.525	118.8 176.7	29.25 743.0	34.90 225.2	706.9 4,560	672.0 4,335	4.67 0.43	7.85 2.39	3,829 159,400	255.3 4,184	10.47 26.61	No Disponible	60 414	
	0.500 12.700	157.7 234.6	29.00 736.6	46.34 299.0	706.9 4,560	660.5 4,261	4.59 0.43	7.85 2.39	5,042 209,900	336.1 5,508	10.43 26.50	No Disponible	60 414	
	0.625 15.875	196.3 292.1	28.75 730.3	57.68 372.1	706.9 4,560	649.2 4,188	4.51 0.42	7.85 2.39	6,224 259,100	414.9 6,800	10.39 26.39	No Disponible	60 414	
	0.750 19.050	234.5 349.0	28.50 723.9	68.92 444.6	706.9 4,560	637.9 4,116	4.43 0.41	7.85 2.39	7,375 307,000	491.7 8,057	10.34 26.28	No Disponible	60 414	
	0.875 22.225	272.4 405.4	28.25 717.6	80.06 516.5	706.9 4,560	626.8 4,044	4.35 0.40	7.85 2.39	8,497 353,700	566.5 9,283	10.30 26.17	No Disponible	60 414	
	1.000 25.400	310.0 461.3	28.00 711.2	91.11 587.8	706.9 4,560	615.8 3,973	4.28 0.40	7.85 2.39	9,589 399,100	639.3 10,480	10.26 26.06	No Disponible	50 345	
36 914	0.375 9.525	142.8 212.5	35.25 895.4	41.97 270.8	1,018 6,567	975.9 6,296	6.78 0.63	9.43 2.87	6,659 277,200	369.9 6,062	12.60 31.99	No Disponible	60 414	60 414
	0.500 12.700	189.8 282.4	35.00 889.0	55.76 359.8	1,018 6,567	962.1 6,207	6.68 0.62	9.43 2.87	8,786 365,700	488.1 7,999	12.55 31.88	No Disponible	60 414	60 414
	0.625 15.875	236.4 351.7	34.75 882.7	69.46 448.1	1,018 6,567	948.4 6,119	6.59 0.61	9.43 2.87	10,870 452,400	603.8 9,894	12.51 31.77	No Disponible	60 414	60 414
	0.750 19.050	282.6 420.6	34.50 876.3	83.06 535.8	1,018 6,567	934.8 6,031	6.49 0.60	9.43 2.87	12,910 537,200	717.0 11,750	12.47 31.66	No Disponible	60 414	60 414
	0.875 22.225	328.6 488.9	34.25 870.0	96.55 622.9	1,018 6,567	921.3 5,944	6.40 0.59	9.43 2.87	14,900 620,200	827.8 13,560	12.42 31.55	No Disponible	50 345	60 414
	1.000 25.400	374.2 556.8	34.00 863.6	110.0 709.4	1,018 6,567	907.9 5,858	6.31 0.59	9.43 2.87	16,850 701,400	936.2 15,340	12.38 31.44	No Disponible	50 345	60 414

TUBERÍA

Diámetro exterior in mm	Espesor de pared in mm	Peso lb/ft kg/m	Diámetro interno in mm	Sección transversal in² cm²	Área total del eje in² cm²	Área interna in² cm²	Volumen interno ft³/ft m³/m	Área de revestimiento ft²/ft m²/m	Momento de inercia in⁴ cm⁴	Módulo de Sección in³ cm³	Radio de giro in cm	Rendimiento máximo disponible fuerza de A252		
												ERW	SH	L y S
												ksi (MPa)		
42 1067	0.375 9.525	166.9 248.3	41.25 1,048	49.04 316.4	1,385 8,938	1,336 8,622	9.28 0.86	11.00 3.35	10,620 442,100	505.8 8,288	14.72 37.38	No Disponible	60 414	60 414
	0.500 12.700	221.8 330.1	41.00 1,041	65.19 420.6	1,385 8,938	1,320 8,518	9.17 0.85	11.00 3.35	14,040 584,200	668.4 10,950	14.67 37.27		60 414	60 414
	0.625 15.875	276.4 411.4	40.75 1,035	81.24 524.1	1,385 8,938	1,304 8,414	9.06 0.84	11.00 3.35	17,390 723,700	828.0 13,570	14.63 37.16		60 414	60 414
	0.750 19.050	330.7 492.2	40.50 1,029	97.19 627.1	1,385 8,938	1,288 8,311	8.95 0.83	11.00 3.35	20,680 860,700	984.7 16,140	14.59 37.05		60 414	60 414
	0.875 22.225	384.7 572.4	40.25 1,022	113.0 729.3	1,385 8,938	1,272 8,209	8.84 0.82	11.00 3.35	23,910 995,200	1,139 18,660	14.54 36.94		50 345	60 414
	1.000 25.400	438.3 652.2	40.00 1,016	128.8 831.0	1,385 8,938	1,257 8,107	8.73 0.81	11.00 3.35	27,080 1,127,000	1,290 21,130	14.50 36.83		50 345	60 414
48 1219	0.375 9.525	190.9 284.1	47.25 1,200	56.11 362.0	1,810 11,670	1,753 11,310	12.18 1.13	12.57 3.83	15,910 662,200	662.8 10,860	16.84 42.77	No Disponible	60 414	60 414
	0.500 12.700	253.9 377.8	47.00 1,194	74.61 481.4	1,810 11,670	1,735 11,190	12.05 1.12	12.57 3.83	21,050 876,000	876.9 14,370	16.79 42.66		60 414	60 414
	0.625 15.875	316.5 471.0	46.75 1,187	93.02 600.1	1,810 11,670	1,717 11,070	11.92 1.11	12.57 3.83	26,100 1,086,000	1,088 17,820	16.75 42.55		60 414	60 414
	0.750 19.050	378.8 563.7	46.50 1,181	111.3 718.3	1,810 11,670	1,698 10,960	11.79 1.10	12.57 3.83	31,080 1,294,000	1,295 21,220	16.71 42.44		60 414	60 414
	0.875 22.225	440.8 656.0	46.25 1,175	129.5 835.8	1,810 11,670	1,680 10,840	11.67 1.08	12.57 3.83	35,970 1,497,000	1,499 24,560	16.66 42.33		60 414	60 414
	1.000 25.400	502.4 747.7	46.00 1,168	147.7 952.6	1,810 11,670	1,662 10,720	11.54 1.07	12.57 3.83	40,790 1,698,000	1,700 27,850	16.62 42.22		60 414	60 414
	1.250 31.750	624.7 929.6	45.50 1,156	183.6 1,184	1,810 11,670	1,626 10,490	11.29 1.05	12.57 3.83	50,190 2,089,000	2,091 34,270	16.53 42.00		No Disponible	60 414
	1.375 34.925	685.3 1,020	45.25 1,149	201.4 1,299	1,810 11,670	1,608 10,380	11.17 1.04	12.57 3.83	54,780 2,280,000	2,282 37,400	16.49 41.89		60 414	60 414
54 1372	0.375 9.525	215.0 319.9	53.25 1,353	63.18 407.6	2,290 14,780	2,227 14,370	15.47 1.44	14.14 4.31	22,710 945,300	841.1 13,780	18.96 48.16	No Disponible	60 414	70 483
	0.500 12.700	286.0 425.5	53.00 1,346	84.04 542.2	2,290 14,780	2,206 14,230	15.32 1.42	14.14 4.31	30,070 1,252,000	1,114 18,250	18.92 48.05		60 414	70 483
	0.625 15.875	356.6 530.7	52.75 1,340	104.8 676.1	2,290 14,780	2,185 14,100	15.18 1.41	14.14 4.31	37,330 1,554,000	1,382 22,650	18.87 47.94		60 414	70 483
	0.750 19.050	426.9 635.3	52.50 1,334	125.5 809.5	2,290 14,780	2,165 13,970	15.03 1.40	14.14 4.31	44,480 1,851,000	1,647 27,000	18.83 47.82		60 414	70 483
	0.875 22.225	496.9 739.5	52.25 1,327	146.0 942.2	2,290 14,780	2,144 13,830	14.89 1.38	14.14 4.31	51,530 2,145,000	1,909 31,280	18.79 47.71		60 414	70 483
	1.000 25.400	566.6 843.12	52.00 1,321	166.5 1,074	2,290 14,780	2,124 13,700	14.75 1.37	14.14 4.31	58,480 2,434,000	2,166 35,500	18.74 47.60		60 414	70 483
	1.250 31.750	704.9 1,049	51.50 1,308	207.1 1,336	2,290 14,780	2,083 13,440	14.47 1.34	14.14 4.31	72,090 3,001,000	2,670 43,750	18.66 47.38		No Disponible	60 414
	1.375 34.925	773.5 1,151	51.25 1,302	227.3 1,467	2,290 14,780	2,063 13,310	14.33 1.33	14.14 4.31	78,750 3,278,000	2,917 47,790	18.61 47.27		60 414	60 414
60 1524	0.375 9.525	239.0 355.7	59.25 1,505	70.24 453.2	2,827 18,240	2,757 17,790	19.15 1.78	15.71 4.79	31,220 1,299,000	1,041 17,050	21.08 53.55	No Disponible	No Disponible	70 483
	0.500 12.700	318.0 473.3	59.00 1,499	93.46 603.0	2,827 18,240	2,734 17,640	18.99 1.76	15.71 4.79	41,360 1,722,000	1,379 22,590	21.04 53.43		60 414	70 483
	0.625 15.875	396.7 590.3	58.75 1,492	116.6 752.1	2,827 18,240	2,711 17,490	18.83 1.75	15.71 4.79	51,380 2,139,000	1,713 28,070	20.99 53.32		60 414	70 483
	0.750 19.050	475.0 706.9	58.50 1,486	139.6 900.7	2,827 18,240	2,688 17,340	18.67 1.73	15.71 4.79	61,270 2,550,000	2,042 33,470	20.95 53.21		60 414	70 483
	0.875 22.225	553.0 823.0	58.25 1,480	162.5 1,049	2,827 18,240	2,665 17,190	18.51 1.72	15.71 4.79	71,040 2,957,000	2,368 38,800	20.91 53.10		60 414	70 483
	1.000 25.400	630.7 938.6	58.00 1,473	185.4 1,196	2,827 18,240	2,642 17,050	18.35 1.71	15.71 4.79	80,680 3,358,000	2,689 44,070	20.86 52.99		60 414	70 483

Diámetro exterior in mm	Espesor de pared in mm	Peso lb/ft kg/m	Diámetro interno in mm	Sección transversal in² cm²	Área total del eje in² cm²	Área interna in² cm²	Volumen interno ft³/ft m³/m	Área de revestimiento ft²/ft m²/m	Momento de inercia in⁴ cm⁴	Módulo de Sección in³ cm³	Radio de giro in cm	Rendimiento máximo disponible fuerza de A252			
												ERW	SH	L y S	
												ksi (MPa)			
60 1524	1.250 31.750	785.1 1,168	5750 1,461	230.7 1,488	2,827 18,240	2,597 16,750	18.03 1.68	15.71 4.79	99,580 4,145,000	3,319 54,400	20.78 52.77	No Disponible	No Disponible	70 483	
	1.500 38.100	938.1 1,396	5700 1,448	275.7 1,779	2,827 18,240	2,552 16,460	17.72 1.65	15.71 4.79	118,000 4,912,000	3,934 64,460	20.69 52.55			60 414	
72 1829	0.375 9.525	287.1 427.3	71.25 1,810	84.38 544.4	4,072 26,270	3,987 25,720	27.69 2.57	18.85 5.75	54,110 2,252,000	1,503 24,630	25.32 64.32	No Disponible	No Disponible	70 483	
	0.500 12.700	382.2 568.7	71.00 1,803	112.3 724.6	4,072 26,270	3,959 25,540	27.49 2.55	18.85 5.75	71,770 2,987,000	1,994 32,670	25.28 64.21			70 483	
	0.625 15.875	476.9 709.6	70.75 1,797	140.1 904.2	4,072 26,270	3,931 25,360	27.30 2.54	18.85 5.75	89,250 3,715,000	2,479 40,630	25.24 64.10			60 414	70 483
	0.750 19.050	571.3 850.1	70.50 1,791	167.9 1,083	4,072 26,270	3,904 25,180	27.11 2.52	18.85 5.75	106,500 4,435,000	2,960 48,500	25.19 63.99			60 414	70 483
	0.875 22.225	665.3 990.0	70.25 1,784	195.5 1,261	4,072 26,270	3,876 25,010	26.92 2.50	18.85 5.75	123,700 5,147,000	3,435 56,290	25.15 63.88			60 414	70 483
	1.000 25.400	759.0 1,129	70.00 1,778	223.1 1,439	4,072 26,270	3,848 24,830	26.73 2.48	18.85 5.75	140,600 5,851,000	3,905 63,990	25.10 63.77			60 414	70 483
	1.250 31.750	945.4 1,407	69.50 1,765	277.8 1,792	4,072 26,270	3,794 24,480	26.34 2.45	18.85 5.75	173,900 7,238,000	4,830 79,160	25.02 63.55			No Disponible	60 414
	1.500 38.100	1,130 1,682	69.00 1,753	332.2 2,143	4,072 26,270	3,739 24,120	25.97 2.41	18.85 5.75	206,500 8,595,000	5,736 94,000	24.93 63.33			60 414	
	84 2134	0.375 9.525	335.2 498.9	83.25 2,115	98.52 635.6	5,542 35,750	5,443 35,120	37.80 3.51	21.99 6.70	86,120 3,585,000	2,050 33,600			29.57 75.10	No Disponible
0.500 12.700		446.3 664.2	83.00 2,108	131.2 846.2	5,542 35,750	5,411 34,910	37.57 3.49	21.99 6.70	114,300 4,758,000	2,722 44,600	29.52 74.99	70 483			
0.625 15.875		557.1 829.0	82.75 2,102	163.7 1,056	5,542 35,750	5,378 34,700	37.35 3.47	21.99 6.70	142,300 5,921,000	3,387 55,500	29.48 74.87	60 414	70 483		
0.750 19.050		667.5 993.3	82.50 2,096	196.2 1,266	5,542 35,750	5,346 34,490	37.12 3.45	21.99 6.70	169,900 7,074,000	4,046 66,310	29.43 74.76	60 414	70 483		
0.875 22.225		777.5 1,157	82.25 2,089	228.5 1,474	5,542 35,750	5,313 34,280	36.90 3.43	21.99 6.70	197,400 8,216,000	4,700 77,010	29.39 74.65	60 414	70 483		
1.000 25.400		887.3 1,320	82.00 2,083	260.8 1,682	5,542 35,750	5,281 34,070	36.67 3.41	21.99 6.70	224,600 9,347,000	5,347 87,620	29.35 74.54	60 414	70 483		
1.250 31.750		1,106 1,645	81.50 2,070	325.0 2,097	5,542 35,750	5,217 33,660	36.23 3.37	21.99 6.70	278,200 11,580,000	6,624 108,500	29.26 74.32	No Disponible	70 483		
1.500 38.100		1,323 1,969	81.00 2,057	388.8 2,508	5,542 35,750	5,153 33,250	35.78 3.32	21.99 6.70	330,900 13,770,000	7,878 129,100	29.17 74.10	70 483			
1.625 41.275		1,431 2,129	80.75 2,051	420.5 2,713	5,542 35,750	5,121 33,040	35.56 3.30	21.99 6.70	356,800 14,850,000	8,496 139,200	29.13 73.99	70 483			
96 2438	0.375 9.525	383.3 570.4	95.25 2,419	112.7 726.8	7,238 46,700	7,126 45,970	49.48 4.60	25.13 7.66	128,800 5,360,000	2,683 43,960	33.81 85.87	No Disponible	No Disponible	70 483	
	0.500 12.700	510.5 759.6	95.00 2,413	150.0 967.8	7,238 46,700	7,088 45,730	49.22 4.57	25.13 7.66	171,000 7,118,000	3,563 58,390	33.76 85.76			70 483	
	0.625 15.875	637.2 948.3	94.75 2,407	187.3 1,208	7,238 46,700	7,051 45,490	48.97 4.55	25.13 7.66	212,900 8,863,000	4,436 72,700	33.72 85.65			60 414	70 483
	0.750 19.050	763.7 1,136	94.50 2,400	224.4 1,448	7,238 46,700	7,014 45,250	48.71 4.53	25.13 7.66	254,500 10,590,000	5,303 86,900	33.68 85.54			60 414	70 483
	0.875 22.225	889.8 1,324	94.25 2,394	261.5 1,687	7,238 46,700	6,977 45,010	48.45 4.50	25.13 7.66	295,800 12,310,000	6,162 101,000	33.63 85.43			60 414	70 483
	1.000 25.400	1,016 1,511	94.00 2,388	298.5 1,925	7,238 46,700	6,940 44,770	48.19 4.48	25.13 7.66	336,700 14,020,000	7,015 115,000	33.59 85.32			60 414	70 483
	1.250 31.750	1,266 1,884	93.50 2,375	372.1 2,401	7,238 46,700	6,866 44,300	47.68 4.43	25.13 7.66	417,600 17,380,000	8,700 142,600	33.50 85.10			No Disponible	70 483
	1.500 38.100	1,515 2,255	93.00 2,362	445.3 2,873	7,238 46,700	6,793 43,830	47.17 4.38	25.13 7.66	497,200 20,700,000	10,360 169,800	33.42 84.87			70 483	
	1.750 44.450	1,763 2,624	92.50 2,350	518.2 3,343	7,238 46,700	6,720 43,360	46.67 4.34	25.13 7.66	575,600 23,960,000	11,990 196,500	33.33 84.65			70 483	
2.000 50.800	2,010 2,991	92.00 2,337	590.6 3,810	7,238 46,700	6,648 42,890	46.16 4.29	25.13 7.66	652,600 27,160,000	13,600 222,800	33.24 84.43	70 483				

TUBERÍA

Diámetro exterior in mm	Espesor de pared in mm	Peso lb/ft kg/m	Diámetro interno in mm	Sección transversal in² cm²	Área total del eje in² cm²	Área interna in² cm²	Volumen interno ft³/ft m³/m	Área de revestimiento ft²/ft m²/m	Momento de inercia in⁴ cm⁴	Módulo de Sección in³ cm³	Radio de giro in cm	Rendimiento máximo disponible fuerza de A252		
												ERW	SH	L y S
												ksi (MPa)		
108 2743	0.375 9.525	431.4 642.0	107.3 2,724	126.8 818.0	9,161 59,100	9,034 58,280	62.74 5.83	28.27 8.62	183,600 7,641,000	3400 55,710	38.05 96.65	No Disponible	No Disponible	70 483
	0.500 12.700	574.6 855.1	107.0 2,718	168.9 1,089	9,161 59,100	8,992 58,010	62.44 5.80	28.27 8.62	243,900 10,150,000	4,517 74,020	38.01 96.54			70 483
	0.625 15.875	717.4 1,068	106.8 2,711	210.8 1,360	9,161 59,100	8,950 57,740	62.15 5.77	28.27 8.62	303,900 12,650,000	5,627 92,210	37.96 96.43		60 414	70 483
	0.750 19.050	859.9 1,280	106.5 2,705	252.7 1,630	9,161 59,100	8,908 57,470	61.86 5.75	28.27 8.62	363,400 15,120,000	6,729 110,300	37.92 96.32		60 414	70 483
	0.875 22.225	1,002 1,491	106.3 2,699	294.5 1,900	9,161 59,100	8,866 57,200	61.57 5.72	28.27 8.62	422,400 17,580,000	7,823 128,200	37.88 96.20		60 414	70 483
	1.000 25.400	1,144 1,702	106.0 2,692	336.2 2,169	9,161 59,100	8,825 56,930	61.28 5.69	28.27 8.62	481,100 20,030,000	8,910 146,000	37.83 96.09		60 414	70 483
	1.250 31.750	1,426 2,123	105.5 2,680	419.2 2,705	9,161 59,100	8,742 56,400	60.71 5.64	28.27 8.62	597,200 24,860,000	11,060 181,200	37.74 95.87		No Disponible	70 483
	1.500 38.100	1,708 2,541	105.0 2,667	501.9 3,238	9,161 59,100	8,659 55,860	60.13 5.59	28.27 8.62	711,700 29,620,000	13,180 216,000	37.66 95.65			70 483
	1.750 44.450	1,988 2,958	104.5 2,654	584.1 3,769	9,161 59,100	8,577 55,330	59.56 5.53	28.27 8.62	824,500 34,320,000	15,268.94 250,200	37.57 95.43			70 483
2.000 50.800	2,266 3,372	104.0 2,642	666.0 4,297	9,161 59,100	8,495 54,810	58.99 5.48	28.27 8.62	935,800 38,950,000	17,330 284,000	37.48 95.21			70 483	
120 3048	0.375 9.525	479.6 713.6	119.3 3,029	140.9 909.2	11,310 72,970	11,170 72,060	77.56 7.21	31.42 9.58	252,100 10,490,000	4,202 68,850	42.29 107.4	No Disponible	No Disponible	70 483
	0.500 12.700	638.7 950.5	119.0 3,023	187.7 1,211	11,310 72,970	11,120 71,750	77.24 7.18	31.42 9.58	335,100 13,950,000	5,585 91,510	42.25 107.3			70 483
	0.625 15.875	797.6 1,187	118.8 3,016	234.4 1,512	11,310 72,970	11,080 71,450	76.91 7.15	31.42 9.58	417,500 17,380,000	6,959 114,000	42.21 107.2		60 414	70 483
	0.750 19.050	956.1 1,423	118.5 3,010	281.0 1,813	11,310 72,970	11,030 71,150	76.59 7.12	31.42 9.58	499,500 20,790,000	8,325 136,400	42.16 107.1		60 414	70 483
	0.875 22.225	1,114 1,658	118.3 3,004	327.5 2,113	11,310 72,970	10,980 70,850	76.27 7.09	31.42 9.58	580,900 24,180,000	9,682 158,700	42.12 107.0		60 414	70 483
	1.000 25.400	1,272 1,893	118.0 2,997	373.8 2,412	11,310 72,970	10,940 70,550	75.94 7.06	31.42 9.58	661,800 27,550,000	11,030 180,800	42.07 106.9		60 414	70 483
	1.250 31.750	1,587 2,361	117.5 2,985	466.3 3,009	11,310 72,970	10,840 69,960	75.30 7.00	31.42 9.58	822,100 34,220,000	13,700 224,500	41.99 106.6		No Disponible	70 483
	1.500 38.100	1,900 2,828	117.0 2,972	558.4 3,603	11,310 72,970	10,750 69,360	74.66 6.94	31.42 9.58	980,300 40,800,000	16,340 267,700	41.90 106.4			70 483
	1.750 44.450	2,212 3,292	116.5 2,959	650.1 4,194	11,310 72,970	10,660 68,770	74.03 6.88	31.42 9.58	1,137,000 47,310,000	18,940 310,400	41.81 106.2			70 483
2.000 50.800	2,523 3,754	116.0 2,946	741.4 4,783	11,310 72,970	10,570 68,180	73.39 6.82	31.42 9.58	1,291,000 53,730,000	21,510 352,500	41.73 106.0			70 483	
132 3353	0.500 12.700	702.9 1,046	131.0 3,327	206.6 1,333	13,680 88,290	13,480 86,960	93.60 8.70	34.56 10.53	446,500 18,580,000	6,765 110,900	46.49 118.1	No Disponible	No Disponible	70 483
	0.625 15.875	877.8 1,306	130.8 3,321	258.0 1,664	13,680 88,290	13,430 86,620	93.24 8.66	34.56 10.53	556,500 23,160,000	8,432 138,200	46.45 118.0			70 483
	0.750 19.050	1,052 1,566	130.5 3,315	309.3 1,995	13,680 88,290	13,380 86,290	92.89 8.63	34.56 10.53	665,900 27,720,000	10,090 165,300	46.40 117.9			70 483
	0.875 22.225	1,227 1,825	130.3 3,308	360.4 2,325	13,680 88,290	13,320 85,960	92.53 8.60	34.56 10.53	774,700 32,250,000	11,740 192,400	46.36 117.8			70 483
	1.000 25.400	1,400 2,084	130.0 3,302	411.5 2,655	13,680 88,290	13,270 85,630	92.18 8.56	34.56 10.53	882,900 36,750,000	13,380 219,200	46.32 117.6			70 483
	1.250 31.750	1,747 2,600	129.5 3,289	513.5 3,313	13,680 88,290	13,170 84,980	91.47 8.50	34.56 10.53	1,097,000 45,670,000	16,630 272,500	46.23 117.4			70 483
	1.500 38.100	2,093 3,114	129.0 3,277	615.0 3,968	13,680 88,290	13,070 84,320	90.76 8.43	34.56 10.53	1,309,000 54,500,000	19,840 325,100	46.14 117.2			70 483
	1.750 44.450	2,437 3,626	128.5 3,264	716.1 4,620	13,680 88,290	12,970 83,670	90.06 8.37	34.56 10.53	1,519,000 63,220,000	23,010 377,100	46.05 117.0			70 483
	2.000 50.800	2,779 4,136	128.0 3,251	816.8 5,270	13,680 88,290	12,870 83,020	89.36 8.30	34.56 10.53	1,726,000 71,840,000	26,150 428,500	45.97 116.8			70 483

Diámetro exterior in mm	Espesor de pared in mm	Peso lb/ft kg/m	Diámetro interno in mm	Sección transversal in ² cm ²	Área total del eje in ² cm ²	Área interna in ² cm ²	Volumen interno ft ³ /ft m ³ /m	Área de revestimiento ft ² /ft m ² /m	Momento de inercia in ⁴ cm ⁴	Módulo de Sección in ³ cm ³	Radio de giro in cm	Rendimiento máximo disponible fuerza de A252		
												ERW	SH	L y S
												ksi (MPa)		
144 3658	0.625 15.875	9579 1,426	142.8 3,626	281.5 1,816	16,290 105,100	16,000 103,300	1111 10.33	3770 11.49	723,400 30,110,000	10,050 164,600	50.69 128.8	No Disponible	No Disponible	70 483
	0.750 19.050	1,149 1,709	142.5 3,620	337.5 2,178	16,290 105,100	15,950 102,900	110.8 10.29	3770 11.49	865,800 36,040,000	12,020 197,100	50.65 128.6			70 483
	0.875 22.225	1,339 1,992	142.3 3,613	393.4 2,538	16,290 105,100	15,890 102,500	110.4 10.25	3770 11.49	1,007,000 41,930,000	13,990 229,300	50.60 128.5			70 483
	1.000 25.400	1,529 2,275	142.0 3,607	449.2 2,898	16,290 105,100	15,840 102,200	110.0 10.22	3770 11.49	1,148,000 47,800,000	15,950 261,400	50.56 128.4			70 483
	1.250 31.750	1,908 2,839	141.5 3,594	560.6 3,617	16,290 105,100	15,730 101,500	109.2 10.15	3770 11.49	1,428,000 59,440,000	19,830 325,000	50.47 128.2			70 483
	1.500 38.100	2,285 3,400	141.0 3,581	671.5 4,332	16,290 105,100	15,610 100,700	108.4 10.07	3770 11.49	1,705,000 70,950,000	23,680 388,000	50.38 128.0			70 483
	1.750 44.450	2,661 3,960	140.5 3,569	782.1 5,046	16,290 105,100	15,500 100,000	107.7 10.00	3770 11.49	1,978,000 82,350,000	27,480 450,300	50.30 127.8			70 483
	2.000 50.800	3,036 4,518	140.0 3,556	892.2 5,756	16,290 105,100	15,390 99,310	106.9 9.93	3770 11.49	2,249,000 93,620,000	31,240 511,900	50.21 127.5			70 483
156 3962	0.625 15.875	1,038 1,545	154.8 3,931	305.1 1,968	19,110 123,300	18,810 121,300	130.6 12.13	40.84 12.45	920,600 38,320,000	11800 193,400	54.93 139.5	No Disponible	No Disponible	80 552
	0.750 19.050	1,245 1,852	154.5 3,924	365.8 2,360	19,110 123,300	18,750 121,000	130.2 12.10	40.84 12.45	1,102,000 45,870,000	14,130 231,500	54.89 139.4			80 552
	0.875 22.225	1,451 2,159	154.3 3,918	426.4 2,751	19,110 123,300	18,690 120,600	129.8 12.06	40.84 12.45	1,283,000 53,390,000	16,440 269,500	54.85 139.3			80 552
	1.000 25.400	1,657 2,466	154.0 3,912	486.9 3,142	19,110 123,300	18,630 120,200	129.4 12.02	40.84 12.45	1,462,000 60,870,000	18,750 307,200	54.80 139.2			80 552
	1.250 31.750	2,068 3,077	153.5 3,899	607.7 3,921	19,110 123,300	18,510 119,400	128.5 11.94	40.84 12.45	1,819,000 75,720,000	23,320 382,200	54.71 139.0			80 552
	1.500 38.100	2,477 3,687	153.0 3,886	728.1 4,697	19,110 123,300	18,390 118,600	127.7 11.86	40.84 12.45	2,173,000 90,430,000	27,850 456,400	54.63 138.8			80 552
	1.750 44.450	2,886 4,294	152.5 3,874	848.0 5,471	19,110 123,300	18,270 117,800	126.8 11.78	40.84 12.45	2,522,000 105,000,000	32,339.61 530,000	54.54 138.5			80 552
	2.000 50.800	3,293 4,900	152.0 3,861	967.6 6,243	19,110 123,300	18,150 117,100	126.0 11.71	40.84 12.45	2,869,000 119,400,000	36,780 602,700	54.45 138.3			80 552
168 4267	0.750 19.050	1,341 1,995	166.5 4,229	394.1 2,542	22,170 143,000	21,770 140,500	151.2 14.05	43.98 13.41	1,378,000 57,350,000	16,400 268,800	59.13 150.2	No Disponible	No Disponible	80 552
	0.875 22.225	1,563 2,326	166.3 4,223	459.4 2,964	22,170 143,000	21,710 140,000	150.7 14.00	43.98 13.41	1,604,000 66,760,000	19,100 312,900	59.09 150.1			80 552
	1.000 25.400	1,785 2,657	166.0 4,216	524.6 3,385	22,170 143,000	21,640 139,600	150.3 13.96	43.98 13.41	1,829,000 76,130,000	21,770 356,800	59.04 150.0			80 552
	1.250 31.750	2,228 3,316	165.5 4,204	654.8 4,225	22,170 143,000	21,510 138,800	149.4 13.88	43.98 13.41	2,276,000 94,740,000	27,100 444,000	58.96 149.7			80 552
	1.500 38.100	2,670 3,973	165.0 4,191	784.6 5,062	22,170 143,000	21,380 138,000	148.5 13.80	43.98 13.41	2,719,000 113,200,000	32,370 530,500	58.87 149.5			80 552
	1.750 44.450	3,110 4,628	164.5 4,178	914.0 5,897	22,170 143,000	21,250 137,100	147.6 13.71	43.98 13.41	3,158,000 131,500,000	37,600 616,100	58.78 149.3			80 552
	2.000 50.800	3,549 5,281	164.0 4,166	1,043 6,729	22,170 143,000	21,120 136,300	146.7 13.63	43.98 13.41	3,593,000 149,600,000	42,780 701,000	58.69 149.1			80 552

TUBERÍA

Especificación de tubería de acero

Al especificar tubería de acero, es importante observar que a menudo hay múltiples especificaciones ASTM involucradas. Bobina de acero, para la producción de ERW y tubería de soldadura en espiral, es fabricada según A1011 y A1018. Esta bobina se hace a menudo para cumplir con los requisitos físicos y químicos de los grados de acero como A36, A572 y A709.

Fabricación de tuberías

Las especificaciones son diferentes a especificaciones de acero y caen bajo especificaciones como A139 y A252. Estas especificaciones controlan las tolerancias de fabricación de la tubería.

Si el diseñador requiere un grado de acero más específico que los requisitos que son descritos en A252 u otras especificaciones de fabricación de tubería, sería aceptable especificar tubería de acero como a continuación. A252 gr. 3 con requerimientos físicos y químicos que cumplen con A572 Gr. 55.

Otros servicios

- Instalación de: Bandas, zapatas de corte, placas finales, dientes de carburo, hierro laminado en perfiles y ángulos, ojos de selección, orejas de elevación, etc.
- Fabricación de conexiones segmentadas: Codos, conexiones Y, laterales, conexiones T, reductores concéntricos y excéntricos.
- Fabricantes de tuberías concéntricas de un espesor de pared de 6.35mm a 50.8mm.
- También disponemos de tuberías fabricadas según el código de soldadura estructural AWS D11 o D15.

ESPECIFICACIONES DE FABRICACIÓN DE TUBERÍAS

	LÍMITE ELÁSTICO		TUBERÍA		
	ksi	MPa	ERW	Soldadura helicoidal	Laminadas y soldadas
A134				✓	
A139 Grado A	30	205		✓	✓
A139 Grado B	35	240		✓	✓
A139 Grado C	42	290		✓	✓
A139 Grado D	46	315		✓	✓
A139 Grado E	52	360		✓	✓
A252 Grado 1	30	205	✓	✓	✓
A252 Grado 2	35	240	✓	✓	✓
A252 Grado 3	45	310	✓	✓	✓
A252 Grado 3 (mod)*	50	345	✓	✓	✓
A500 Grado A	33	288	✓		
A500 Grado B	42	290	✓		
A500 Grado C	46	317	✓		
A500 Grado D	36	250	✓		
AWWA C-200				✓	

ESPECIFICACIONES DE ACERO DISPONIBLES

	LÍMITE ELÁSTICO		TUBERÍA		
	ksi	MPa	ERW	Soldadura helicoidal	Laminadas y soldadas
A36	36	250			✓
A516 Grado 55	30	205			✓
A516 Grado 60	32	220			✓
A516 Grado 65	35	240			✓
A516 Grado 70	38	260			✓
A572 Grado 42	42	290	✓	✓	✓
A572 Grado 50	50	345	✓	✓	✓
A572 Grado 55	55	380	✓	✓	✓
A572 Grado 60	60	415	✓	✓	✓
A572 Grado 65	65	450	✓	✓	✓
A588	50	345	✓	✓	✓
A690*	50	390	✓	✓	
A709	50	345	✓	✓	
A1011	50	345	✓	✓	
A1018	50	345	✓	✓	

*Para conocer la disponibilidad de otros límites de rendimiento, comuníquese con Nucor Skyline.

TOLERANCIAS DE ENTREGA

	A139	A252	A500	A1085	AWWA C200
Diámetro exterior	± 1%	± 1%	± 0.75%	± 0.75%	+ $\frac{1}{8}$ " / - $\frac{1}{16}$ "
Espesor	- 12.5%	- 12.5%	±10%	+10% / -5%	+10% / -5%
Peso	+10% / -5%	+10% / -5%	±10%	+10% / -3.5%	+10% / -5%
Longitud	± ½"	± 1"	+¾" / -¾"	+¾" / -¾"	± 2"

LONGITUDES MÁXIMAS**

ERW (16" OD and under)	90 ft	27.4 m
ERW (18" OD and over)	115 ft	31.1 m
Tubería con soldadura helicoidal	130 ft	39.6 m
Tuberías laminadas y soldadas	120 ft	36.6 m

** Es posible fabricar el trabajo en longitudes mayores a pedido.

PERFILES ESTRUCTURALES

Nucor Skyline se enorgullece en proporcionar una amplia gama de secciones estructurales. Se encuentran disponibles todas las secciones (incluyendo vigas y columnas) encontradas en el manual del American Institute of Steel Construction (AISC).

Aplicaciones de perfiles estructurales

Los contratistas de cimentaciones utilizan vigas y columnas de acero para sistemas de apuntalamiento de ataguías, muros Berlín, y muros de pilotes secantes.

Las secciones canal se utilizan con frecuencia para fabricar largueros para sistemas de anclaje y vigas de reparto (madrinas) para muros de tablestacas.



Newark, NJ



Chicago, IL



Snohomish County, WA

VIGAS

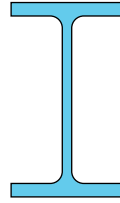

GRADOS DE ACERO DISPONIBLES PARA PERFILES ESTRUCTURALES

ESTADOUNIDENSE			CANADIENSE		
ASTM	LÍMITE ELÁSTICO		CSA G40.21	LÍMITE ELÁSTICO	
	MPa	ksi		MPa	ksi
A 36	250	36	Grado 350 W	350	50
A 572 Grado 50	345	50			
A 588	345	50			
A 709	345	50			
A 913	345	50			
A 913	450	65			
A 992	345	50			

TOLERANCIAS DE ENTREGA

	ASTM A 6		
Peso	± 2.5%		
Peralte	± 3.17mm		
Longitud	≤ 9.14m	> 9.14m	
Vigas W 24 e inferiores	± 9.52mm	25.4"/mm((0.375" + (Longitud - 30) / 80)	9.52mm
Vigas más de W 24	± 12.7mm	25.4"/mm (0.5" + (Longitud - 30) / 80)	9.52mm
Bridas descuadradas			
Vigas W 12 e inferiores	≤ 6.35mm		
Vigas mayores a W 12	≤ 7.94mm		
Entrelazado descentrado	≤ 4.76mm		
Peralte máxima sobre teóricos	≤ 6.35mm		
Inclinación y barrido	25.4"/mm((0.125"(Longitud / 10))		
Inclinación y barrido para columnas*			
45 pies y menos	25.4"/mm(0.125"(Longitud / 10) pero no más que 0.375")		
Más de 45 pies	25.4"/mm((0.375" + (0.125" * (Longitud - 45) / 10))		

*Las secciones más pesadas que la W8x31, W10x49, W12x65 y, W14x90 deberán ser pedidas como pilotes. Si otras secciones se encuentran dispuestas en columnas, las tolerancias están sujetas a la especificación del fabricante, o tolerancias según las necesidades de su proyecto.

VIGAS DE ALA ANCHA

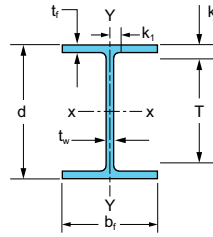

Tamaño del haz		Área A	Profundidad d	Alma		Ala		Distancia					Criterios de sección compacta	
				Espesor t _w	t _w /2	b _f	t _f	k		k ₁	T	Calibre viable	b _f /2t _f	h/t _w
								k _{des}	k _{det}					
mm ²	in ²	mm	in	mm	in	mm	in	mm	in	mm	in	mm	in	
W1100 W44	x 499	63500	1120	26.2	12.7	404	45.0	65.0	66.7	33.3	984.25	139.7	4.50	38.0
	x 335	98.5	44.0	1.03	½	15.9	1.77	2.56	2 5/8	15/16	38 ¾	5 ½	4.50	38.0
	x 433	55100	1110	22.0	11.1	401	40.1	59.9	61.9	31.8			5.02	45.0
	x 290	85.4	43.6	0.865	7/16	15.8	1.58	2.36	2 7/16	1 ¼			5.02	45.0
	x 390	49800	1100	19.9	11.1	401	36.1	55.9	57.2	30.2			5.57	49.6
x 262	77.2	43.3	0.785	7/16	15.8	1.42	2.20	2 ¼	1 3/16			5.57	49.6	
x 343	43700	1090	18.0	9.52	401	31.0	51.1	52.4	30.2			6.45	54.8	
x 230	67.8	42.9	0.710	3/8	15.8	1.22	2.01	2 1/16	1 3/16			6.45	54.8	
W1000 W40	x 883	112000	1090	45.5	23.8	424	82.0	112	114	54.0	863.6	190.5	2.58	19.1
	x 593	174	43.0	1.79	15/16	16.7	3.23	4.41	4 1/2	2 1/8	34	7 1/2	2.58	19.1
	x 748	95500	1070	39.1	20.6	417	70.1	100	102	50.8			2.98	22.3
	x 503	148	42.1	1.54	13/16	16.4	2.76	3.94	4	2			2.98	22.3
	x 642	81900	1050	34.0	17.5	411	59.9	89.9	92.1	47.6			3.44	25.5
	x 431	127	41.3	1.34	11/16	16.2	2.36	3.54	3 5/8	1 7/8			3.44	25.5
	x 591	75500	1040	31.0	15.9	409	55.9	85.9	88.9	46.0			3.66	28.0
	x 397	117	41.0	1.22	5/8	16.1	2.20	3.38	3 1/2	1 13/16			3.66	28.0
	x 554	71000	1030	29.5	15.9	409	52.1	82.0	84.1	46.0			3.93	29.5
	x 372	110	40.6	1.16	5/8	16.1	2.05	3.23	3 5/16	1 13/16			3.93	29.5
	x 539	68400	1030	28.4	14.3	406	51.1	81.0	82.6	44.5			3.99	30.5
	x 362	106	40.6	1.12	9/16	16.0	2.01	3.19	3 1/4	1 3/4			3.99	30.5
	x 483	61500	1020	25.4	12.7	404	46.0	75.9	77.8	42.9			4.40	34.2
	x 324	95.3	40.2	1.00	1/2	15.9	1.81	2.99	3 1/16	1 11/16			4.40	34.2
	x 443	56300	1010	23.6	12.7	401	41.9	71.9	74.6	42.9			4.80	36.8
x 297	87.3	39.8	0.930	1/2	15.8	1.65	2.83	2 15/16	1 11/16			4.80	36.8	
x 412	52600	1010	21.1	11.1	401	40.1	70.1	73.0	41.3			5.03	41.2	
x 277	81.5	39.7	0.830	7/16	15.8	1.58	2.76	2 7/8	1 5/8			5.03	41.2	
x 371	47400	1000	19.1	9.52	401	36.1	66.0	68.3	39.7			5.55	45.6	
x 249	73.5	39.4	0.750	3/8	15.8	1.42	2.60	2 11/16	1 9/16			5.55	45.6	
x 321	41000	991	16.5	7.94	401	31.0	61.0	63.5	39.7			6.45	52.6	
x 215	63.5	39.0	0.650	5/16	15.8	1.22	2.40	2 ½	1 9/16			6.45	52.6	
x 296	37900	983	16.5	7.94	401	27.2	57.2	58.7	39.7			7.39	52.6	
x 199	58.8	38.7	0.650	5/16	15.8	1.07	2.25	2 5/16	1 9/16			7.39	52.6	
W1000 W40	x 584	74800	1060	36.1	19.0	315	64.0	94.0	96.8	49.2	863.6	190.5	2.45	24.1
	x 392	116	41.6	1.42	¾	12.4	2.52	3.70	3 13/16	1 15/16	34	7 ½	2.45	24.1
	x 494	63000	1040	31.0	15.9	310	54.1	84.1	85.7	46.0			2.86	28.0
	x 331	97.7	40.8	1.22	5/8	12.2	2.13	3.31	3 3/8	1 13/16			2.86	28.0
	x 486	61900	1040	30.0	15.9	307	54.1	84.1	85.7	46.0			2.85	29.0
	x 327	95.9	40.8	1.18	5/8	12.1	2.13	3.31	3 3/8	1 13/16			2.85	29.0
	x 438	55600	1030	26.9	14.3	305	49.0	79.0	81.0	44.5			3.11	32.2
	x 294	86.2	40.4	1.06	9/16	12.0	1.93	3.11	3 3/16	1 ¼			3.11	32.2
	x 415	53100	1020	26.2	12.7	305	46.0	75.9	77.8	44.5			3.31	33.3
	x 278	82.3	40.2	1.03	½	12.0	1.81	2.99	3 1/16	1 ¼			3.31	33.3
	x 393	49900	1020	24.4	12.7	302	43.9	73.9	76.2	42.9			3.45	35.6
	x 264	77.4	40.0	0.960	½	11.9	1.73	2.91	3	1 11/16			3.45	35.6
	x 350	44600	1010	21.1	11.1	302	40.1	70.1	73.0	41.3			3.77	41.2
	x 235	69.1	39.7	0.830	7/16	11.9	1.58	2.76	2 7/8	1 5/8			3.77	41.2
	x 314	40100	1000	19.1	9.52	300	36.1	66.0	68.3	39.7			4.17	45.6
x 211	62.1	39.4	0.750	3/8	11.8	1.42	2.60	2 11/16	1 9/16			4.17	45.6	
x 272	34400	991	16.5	7.94	300	30.5	60.5	63.5	39.7			4.92	52.6	
x 183	53.3	39.0	0.650	5/16	11.8	1.20	2.38	2 ½	1 9/16			4.92	52.6	
x 249	31800	980	16.5	7.94	300	26.2	56.1	58.7	39.7			5.76	52.6	
x 167	49.3	38.6	0.650	5/16	11.8	1.03	2.21	2 5/16	1 9/16			5.76	52.6	
x 222	28300	970	16.0	7.94	300	21.1	51.1	54.0	38.1			7.11	54.3	
x 149	43.8	38.2	0.630	5/16	11.8	0.830	2.01	2 1/8	1 ½			7.11	54.3	

PERFILES ESTRUCTURALES
VIGAS DE ALA ANCHA

Peso nominal	Eje X-X				Eje Y-Y				rts	ho	Propiedades de torsión		Área de revestimiento
	I	S	r	Z	I	S	r	Z			J	Cw	
kg/m lb/ft	mm ⁴ /10 ⁶ in ⁴	mm ³ /10 ³ in ³	mm in	in ³ mm ³ /10 ³	mm ⁴ /10 ⁶ in ⁴	mm ³ /10 ³ in ³	mm in	mm ³ /10 ³ in ³	mm in	mm in	mm ⁴ /10 ³ in ⁴	mm ⁶ /10 ⁶ in ⁶	m ² /m ft ² /ft
499 335	12900 31100	23100 1410	452 17.8	26500 1620	499 1200	2460 150	88.6 3.49	3870 236	108 4.24	1070 42.2	31100 74.7	144000 535000	3.80 12.46
433 290	11200 27000	20300 1240	452 17.8	23100 1410	433 1040	2160 132	88.6 3.49	3360 205	107 4.20	1070 42.0	21200 50.9	124000 461000	3.78 12.39
390 262	10000 24100	18200 1110	450 17.7	20800 1270	384 923	1920 117	88.1 3.47	2980 182	106 4.17	1060 41.9	15500 37.3	109000 405000	3.77 12.35
343 230	8660 20800	15900 971	445 17.5	18000 1100	331 796	1660 101	87.1 3.43	2570 157	105 4.13	1060 41.7	10400 24.9	92900 346000	3.75 12.30
883 593	21000 50400	38300 2340	432 17.0	45200 2760	1050 2520	4950 302	96.5 3.80	7880 481	118 4.63	1010 39.8	185000 445	268000 997000	3.79 12.44
748 503	17300 41600	32400 1980	427 16.8	38000 2320	849 2040	4080 249	94.5 3.72	6460 394	114 4.50	998 39.3	115000 277	212000 789000	3.73 12.23
642 431	14500 34800	27700 1690	422 16.6	32100 1960	703 1690	3410 208	92.7 3.65	5370 328	112 4.41	988 38.9	73700 177	171000 638000	3.68 12.06
591 397	13300 32000	25600 1560	422 16.6	29500 1800	641 1540	3130 191	92.5 3.64	4920 300	111 4.38	986 38.8	59100 142	155000 579000	3.66 12.00
554 372	12300 29600	23900 1460	419 16.5	27500 1680	591 1420	2900 177	91.4 3.60	4540 277	110 4.33	980 38.6	48300 116	142000 528000	3.64 11.94
539 362	12000 28900	23300 1420	419 16.5	26900 1640	574 1380	2830 173	91.4 3.60	4420 270	110 4.33	980 38.6	45400 109	138000 513000	3.63 11.91
483 324	10700 25600	21000 1280	417 16.4	23900 1460	508 1220	2510 153	90.9 3.58	3920 239	108 4.27	975 38.4	33000 79.4	120000 448000	3.61 11.83
443 297	9660 23200	19200 1170	414 16.3	21800 1330	454 1090	2260 138	89.9 3.54	3520 215	107 4.22	970 38.2	25500 61.2	107000 399000	3.58 11.75
412 277	9120 21900	18000 1100	417 16.4	20500 1250	433 1040	2160 132	90.9 3.58	3340 204	108 4.25	968 38.1	21400 51.5	102000 379000	3.58 11.75
371 249	8160 19600	16300 993	414 16.3	18400 1120	385 926	1930 118	90.2 3.55	2980 182	107 4.21	965 38.0	15900 38.1	89700 334000	3.57 11.71
321 215	6950 16700	14100 859	411 16.2	15800 964	334 803	1660 101	89.9 3.54	2560 156	106 4.19	960 37.8	10300 24.8	76300 284000	3.55 11.66
296 199	6200 14900	12600 770	406 16.0	14200 869	289 695	1450 88.2	87.6 3.45	2250 137	105 4.12	955 37.6	7620 18.3	66100 246000	3.54 11.61
584 392	12400 29900	23600 1440	409 16.1	28000 1710	334 803	2130 130	67.1 2.64	3470 212	83.8 3.30	993 39.1	71600 172	82200 306000	3.30 10.83
494 331	10300 24700	19800 1210	404 15.9	23400 1430	268 644	1740 106	65.3 2.57	2820 172	81.5 3.21	983 38.7	43700 105	64700 241000	3.25 10.66
486 327	10200 24500	19700 1200	406 16.0	23100 1410	266 640	1720 105	65.5 2.58	2790 170	81.5 3.21	983 38.7	42900 103	64200 239000	3.24 10.64
438 294	9120 21900	17700 1080	404 15.9	20800 1270	234 562	1530 93.5	64.8 2.55	2460 150	80.3 3.16	978 38.5	31900 76.6	55900 208000	3.22 10.56
415 278	8530 20500	16700 1020	401 15.8	19500 1190	217 521	1430 87.1	64.0 2.52	2290 140	79.5 3.13	975 38.4	27100 65.0	51600 192000	3.21 10.53
393 264	8070 19400	15900 971	401 15.8	18500 1130	205 493	1350 82.6	64.0 2.52	2160 132	79.2 3.12	973 38.3	23400 56.1	48600 181000	3.19 10.47
350 235	7240 17400	14300 875	404 15.9	16600 1010	185 444	1220 74.6	64.5 2.54	1930 118	79.0 3.11	968 38.1	17200 41.3	43200 161000	3.18 10.45
314 211	6450 15500	12900 786	401 15.8	14800 906	162 390	1080 66.1	63.8 2.51	1720 105	78.0 3.07	965 38.0	12700 30.4	37900 141000	3.16 10.38
272 183	5490 13200	11100 675	399 15.7	12700 774	138 331	918 56.0	63.2 2.49	1450 88.3	77.2 3.04	960 37.8	8030 19.3	31700 118000	3.15 10.33
249 167	4830 11600	9830 600	389 15.3	11400 693	118 283	785 47.9	61.0 2.40	1250 76.0	75.7 2.98	955 37.6	5830 14.0	26800 99700	3.13 10.26
222 149	4080 9800	8410 513	381 15.0	9800 598	95.3 229	636 38.8	58.2 2.29	1020 62.2	73.4 2.89	950 37.4	3900 9.36	21500 80000	3.11 10.20

VIGAS DE ALA ANCHA

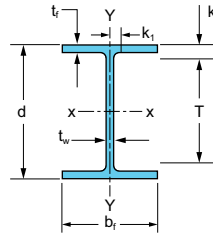

Tamaño del haz		Área A	Profundidad d	Alma		Ala		Distancia				Criterios de sección compacta		
				Espesor t _w	t _w /2	b _f	t _f	k		k ₁	T			Calibre viable
								k _{des}	k _{det}					
		mm ² in ²	mm in	mm in	mm in	mm in	mm in	mm in	mm in	mm in	mm in	b _f /2t _f	h/t _w	
W920 W36	x 970	124000	1040	50.0	25.4	447	89.9	114	122	55.6	796.93	190.5	2.48	16.3
	x 652	192	41.1	1.97	1	17.6	3.54	4.49	4 13/16	2 3/16	31 3/8	7 1/2	2.48	16.3
	x 787	101000	1010	40.9	20.6	437	73.9	98.0	106	50.8			2.96	19.9
	x 529	156	39.8	1.61	13/16	17.2	2.91	3.86	4 3/16	2			2.96	19.9
	x 725	92300	998	38.1	19.0	434	68.1	92.2	102	47.6			3.19	21.4
	x 487	143	39.3	1.50	3/4	17.1	2.68	3.63	4	17/8			3.19	21.4
	x 656	83900	988	34.5	17.5	432	62.0	86.1	95.3	47.6			3.48	23.6
	x 441	130	38.9	1.36	11/16	17.0	2.44	3.39	3 3/4	17/8			3.48	23.6
	x 588	74800	975	31.0	15.9	427	55.9	80.0	87.3	46.0			3.83	26.3
	x 395	116	38.4	1.22	5/8	16.8	2.20	3.15	3 7/16	1 13/16			3.83	26.3
	x 537	68400	965	28.4	14.3	424	51.1	75.2	84.1	44.5			4.16	28.6
	x 361	106	38.0	1.12	9/16	16.7	2.01	2.96	3 5/16	1 1/4			4.16	28.6
x 491	62500	958	25.9	12.7	422	47.0	71.1	79.4	44.5			4.49	31.4	
x 330	96.9	37.7	1.02	1/2	16.6	1.85	2.80	3 1/8	1 1/4			4.49	31.4	
x 449	57400	947	24.0	12.7	424	42.7	66.8	76.2	42.9			4.96	33.9	
x 302	89.0	37.3	0.945	1/2	16.7	1.68	2.63	3	1 11/16			4.96	33.9	
x 420	53500	942	22.5	11.1	422	39.9	64.0	73.0	41.3			5.29	36.2	
x 282	82.9	37.1	0.885	7/16	16.6	1.57	2.52	2 7/8	1 5/8			5.29	36.2	
x 390	49800	937	21.3	11.1	422	36.6	60.7	69.9	41.3			5.75	38.2	
x 262	77.2	36.9	0.840	7/16	16.6	1.44	2.39	2 3/4	1 5/8			5.75	38.2	
x 368	46800	932	20.3	11.1	419	34.3	58.4	66.7	41.3			6.11	40.1	
x 247	72.5	36.7	0.800	7/16	16.5	1.35	2.30	2 5/8	1 5/8			6.11	40.1	
x 344	44000	927	19.3	9.52	419	32.0	56.1	65.1	39.7			6.54	42.2	
x 231	68.2	36.5	0.760	3/8	16.5	1.26	2.21	2 9/16	1 9/16			6.54	42.2	
W920 W36	x 381	48600	951	24.4	12.7	310	43.9	63.0	66.7	33.3	815.96	139.7	3.53	33.8
	x 256	75.3	37.4	0.960	1/2	12.2	1.73	2.48	2 5/8	1 5/16	32 1/8	5 1/2	3.53	33.8
	x 345	43900	943	22.1	11.1	307	39.9	58.9	61.9	31.8			3.86	37.3
	x 232	68.0	37.1	0.870	7/16	12.1	1.57	2.32	2 7/16	1 1/4			3.86	37.3
	x 313	39900	932	21.1	11.1	310	34.5	53.6	58.7	31.8			4.48	39.1
	x 210	61.9	36.7	0.830	7/16	12.2	1.36	2.11	2 5/16	1 1/4			4.48	39.1
	x 289	36800	927	19.4	9.52	307	32.0	51.1	55.6	30.2			4.81	42.4
	x 194	57.0	36.5	0.765	3/8	12.1	1.26	2.01	2 3/16	1 3/16			4.81	42.4
	x 271	34600	922	18.4	9.52	307	30.0	49.0	54.0	30.2			5.12	44.8
	x 182	53.6	36.3	0.725	3/8	12.1	1.18	1.93	2 1/8	1 3/16			5.12	44.8
x 253	32300	919	17.3	9.52	305	27.9	47.0	50.8	30.2			5.47	47.7	
x 170	50.0	36.2	0.680	3/8	12.0	1.10	1.85	2	1 3/16			5.47	47.7	
x 238	30300	914	16.5	7.94	305	25.9	45.0	49.2	28.6			5.88	49.9	
x 160	47.0	36.0	0.650	5/16	12.0	1.02	1.77	1 15/16	1 1/8			5.88	49.9	
x 223	28600	912	15.9	7.94	305	23.9	42.9	47.6	28.6			6.37	51.9	
x 150	44.3	35.9	0.625	5/16	12.0	0.940	1.69	1 7/8	1 1/8			6.37	51.9	
x 201	25700	904	15.2	7.94	305	20.1	39.1	42.9	28.6			7.56	54.1	
x 135	39.9	35.6	0.600	5/16	12.0	0.790	1.54	1 11/16	1 1/8			7.56	54.1	

PERFILES ESTRUCTURALES

VIGAS DE ALA ANCHA

Peso nominal	Eje X-X				Eje Y-Y				rts	ho	Propiedades de torsión		Área de revestimiento
	I	S	r	Z	I	S	r	Z			J	Cw	
kg/m lb/ft	mm ⁴ /10 ⁶ in ⁴	mm ³ /10 ³ in ³	mm in	in ³ mm ³ /10 ³	mm ⁴ /10 ⁶ in ⁴	mm ³ /10 ³ in ³	mm in	mm ³ /10 ³ in ³	mm in	mm in	mm ⁴ /10 ³ in ⁴	mm ⁶ /10 ⁶ in ⁶	m ² /m ft ² /ft
970 652	21100 50600	40300 2460	411 16.2	47700 2910	1340 3230	6010 367	104 4.10	9520 581	126 4.96	955 37.6	247000 593	303000 1130000	3.78 12.39
787 529	16500 39600	32600 1990	406 16.0	38200 2330	1040 2490	4740 289	102 4.00	7440 454	122 4.80	937 36.9	136000 327	227000 846000	3.69 12.10
725 487	15000 36000	30000 1830	401 15.8	34900 2130	937 2250	4310 263	101 3.96	6750 412	120 4.74	930 36.6	107000 258	202000 754000	3.66 12.00
656 441	13400 32100	27000 1650	399 15.7	31300 1910	828 1990	3850 235	99.6 3.92	6030 368	119 4.69	927 36.5	80700 194	178000 661000	3.63 11.92
588 395	11900 28500	24400 1490	399 15.7	28000 1710	728 1750	3410 208	98.6 3.88	5330 325	117 4.61	919 36.2	59100 142	154000 575000	3.60 11.80
537 361	10700 25700	22100 1350	396 15.6	25400 1550	653 1570	3080 188	97.8 3.85	4800 293	116 4.58	914 36.0	45400 109	137000 509000	3.57 11.71
491 330	9700 23300	20300 1240	394 15.5	23100 1410	591 1420	2800 171	97.3 3.83	4340 265	115 4.53	912 35.9	35100 84.3	122000 456000	3.55 11.65
449 302	8780 21100	18500 1130	391 15.4	21000 1280	541 1300	2560 156	97.0 3.82	3950 241	115 4.53	904 35.6	26800 64.3	111000 412000	3.54 11.63
420 282	8160 19600	17200 1050	391 15.4	19500 1190	499 1200	2360 144	96.5 3.80	3650 223	114 4.50	902 35.5	21900 52.7	102000 378000	3.53 11.57
390 262	7450 17900	15900 972	389 15.3	18000 1100	454 1090	2160 132	95.5 3.76	3340 204	113 4.46	902 35.5	17300 41.6	91800 342000	3.52 11.54
368 247	6950 16700	15000 913	386 15.2	16900 1030	420 1010	2020 123	95.0 3.74	3110 190	112 4.42	899 35.4	14400 34.7	84900 316000	3.50 11.48
344 231	6490 15600	14000 854	384 15.1	15800 963	391 940	1870 114	94.2 3.71	2880 176	112 4.40	894 35.2	11900 28.7	78400 292000	3.49 11.46
381 256	6990 16800	14700 895	378 14.9	17000 1040	220 528	1420 86.5	67.3 2.65	2250 137	82.3 3.24	907 35.7	22000 52.9	45100 168000	3.09 10.14
345 232	6240 15000	13300 809	376 14.8	15300 936	195 468	1270 77.2	66.5 2.62	2000 122	81.5 3.21	902 35.5	16500 39.6	39700 148000	3.07 10.07
313 210	5490 13200	11800 719	371 14.6	13700 833	171 411	1110 67.5	65.5 2.58	1750 107	80.8 3.18	897 35.3	11700 28.0	34400 128000	3.06 10.05
289 194	5040 12100	10900 664	371 14.6	12600 767	156 375	1010 61.9	65.0 2.56	1600 97.7	80.0 3.15	894 35.2	9240 22.2	31200 116000	3.04 9.99
271 182	4700 11300	10200 623	368 14.5	11800 718	144 347	944 57.6	64.8 2.55	1490 90.7	79.5 3.13	892 35.1	7700 18.5	28700 107000	3.04 9.96
253 170	4370 10500	9520 581	368 14.5	10900 668	133 320	872 53.2	64.3 2.53	1370 83.8	79.0 3.11	892 35.1	6290 15.1	26500 98500	3.02 9.92
238 160	4060 9760	8880 542	366 14.4	10200 624	123 295	805 491	63.5 2.50	1270 77.3	78.5 3.09	889 35.0	5160 12.4	24200 90200	3.01 9.89
223 150	3760 9040	8260 504	363 14.3	9520 581	112 270	739 45.1	62.7 2.47	1160 70.9	77.7 3.06	889 35.0	4200 10.1	22100 82200	3.01 9.88
201 135	3250 7800	7190 439	356 14.0	8340 509	93.7 225	618 37.7	60.5 2.38	978 59.7	75.9 2.99	884 34.8	2910 7.00	18300 68100	3.00 9.83

VIGAS DE ALA ANCHA

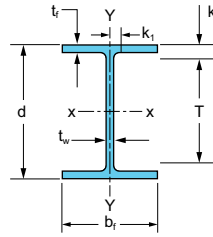

Tamaño del haz		Área A	Profundidad d	Alma		Ala		Distancia				Criterios de sección compacta		
				Espesor t _w	t _w /2	b _f	t _f	k		k ₁	T			Calibre viable
								k _{des}	k _{det}			mm	mm	
W840 W33	x 576	73500	914	32.0	15.9	411	579	78.0	81.0	36.5	752.48	139.7	3.55	23.7
	x 387	114	36.0	1.26	5/8	16.2	2.28	3.07	3 3/16	17/16	29 5/8	5 1/2	3.55	23.7
	x 527	67100	904	29.5	15.9	409	531	73.2	74.6	34.9			3.85	25.7
	x 354	104	35.6	1.16	5/8	16.1	2.09	2.88	2 15/16	13/8			3.85	25.7
	x 473	60500	894	26.4	14.3	406	48.0	68.1	69.9	33.3			4.23	28.7
	x 318	93.7	35.2	1.04	9/16	16.0	1.89	2.68	2 1/4	15/16			4.23	28.7
	x 433	55200	884	24.4	12.7	404	43.9	64.0	66.7	33.3			4.60	31.0
x 291	85.6	34.8	0.960	1/2	15.9	1.73	2.52	2 5/8	15/16			4.60	31.0	
W840 W33	x 392	49900	876	22.1	11.1	401	39.9	59.9	61.9	31.8			5.03	34.3
	x 263	77.4	34.5	0.870	7/16	15.8	1.57	2.36	2 7/16	1 1/4			5.03	34.3
	x 359	45900	869	21.1	11.1	404	35.6	55.6	57.2	31.8			5.66	35.9
	x 241	71.1	34.2	0.830	7/16	15.9	1.40	2.19	2 1/4	1 1/4			5.66	35.9
	x 329	42100	861	19.7	9.52	401	32.5	52.3	54.0	30.2			6.20	38.5
	x 221	65.3	33.9	0.775	3/8	15.8	1.28	2.06	2 1/8	1 3/16			6.20	38.5
	x 299	38100	856	18.2	9.52	399	29.2	49.3	50.8	30.2			6.85	41.7
x 201	59.1	33.7	0.715	3/8	15.7	1.15	1.94	2	1 3/16			6.85	41.7	
W840 W33	x 251	31900	859	17.0	9.52	292	31.0	48.8	54.0	30.2	752.48	139.7	4.71	44.7
	x 169	49.5	33.8	0.670	3/8	11.5	1.22	1.92	2 1/8	1 3/16	29 5/8	5 1/2	4.71	44.7
	x 226	29000	851	16.1	7.94	295	26.9	44.7	49.2	28.6			5.48	47.2
	x 152	44.9	33.5	0.635	5/16	11.6	1.06	1.76	1 15/16	1 1/8			5.48	47.2
	x 210	26800	846	15.4	7.94	292	24.4	42.2	46.0	28.6			6.01	49.6
W760 W30	x 141	41.5	33.3	0.605	5/16	11.5	0.960	1.66	1 13/16	1 1/8			6.01	49.6
	x 193	24700	841	14.7	7.94	292	21.7	39.6	44.5	28.6			6.73	51.7
	x 130	38.3	33.1	0.580	5/16	11.5	0.855	1.56	1 3/4	1 1/8			6.73	51.7
	x 176	22400	836	14.0	7.94	292	18.8	36.6	41.3	28.6			7.76	54.5
	x 118	34.7	32.9	0.550	5/16	11.5	0.740	1.44	1 5/8	1 1/8			7.76	54.5
W760 W30	x 582	74200	843	34.5	17.5	396	62.0	82.0	85.7	38.1	673.1	139.7	3.19	19.7
	x 391	115	33.2	1.36	11/16	15.6	2.44	3.23	3 3/8	1 1/2	26 1/2	5 1/2	3.19	19.7
	x 531	67700	833	31.5	15.9	394	56.9	77.0	79.4	36.5			3.45	21.6
	x 357	105	32.8	1.24	5/8	15.5	2.24	3.03	3 1/8	1 7/16			3.45	21.6
	x 484	61900	823	29.0	14.3	391	52.1	72.1	74.6	34.9			3.75	23.4
	x 326	95.9	32.4	1.14	9/16	15.4	2.05	2.84	2 15/16	1 3/8			3.75	23.4
	x 434	55500	813	25.9	12.7	389	47.0	67.1	69.9	33.3			4.12	26.2
	x 292	86.0	32.0	1.02	1/2	15.3	1.85	2.64	2 3/4	1 5/16			4.12	26.2
	x 389	49700	803	23.6	12.7	386	41.9	62.0	65.1	33.3			4.59	28.7
x 261	77.0	31.6	0.930	1/2	15.2	1.65	2.44	2 9/16	1 5/16			4.59	28.7	
W760 W30	x 350	44700	795	21.1	11.1	384	38.1	58.2	60.3	31.8			5.02	32.2
	x 235	69.3	31.3	0.830	7/16	15.1	1.50	2.29	2 3/8	1 1/4			5.02	32.2
	x 314	40200	785	19.7	9.52	384	33.5	53.3	57.2	30.2			5.74	34.5
	x 211	62.3	30.9	0.775	3/8	15.1	1.32	2.10	2 1/4	1 3/16			5.74	34.5
	x 284	36200	780	18.0	9.52	381	30.2	50.0	52.4	30.2			6.35	37.7
	x 191	56.1	30.7	0.710	3/8	15.0	1.19	1.97	2 1/16	1 3/16			6.35	37.7
	x 257	32800	772	16.6	7.94	381	27.2	47.0	50.8	28.6			7.04	40.8
x 173	50.9	30.4	0.655	5/16	15.0	1.07	1.85	2	1 1/8			7.04	40.8	

PERFILES ESTRUCTURALES

VIGAS DE ALA ANCHA

Peso nominal	Eje X-X				Eje Y-Y				rts	ho	Propiedades de torsión		Área de revestimiento
	I	S	r	Z	I	S	r	Z			J	Cw	
kg/m lb/ft	mm ⁴ /10 ⁶ in ⁴	mm ³ /10 ³ in ³	mm in	in ³ mm ³ /10 ³	mm ⁴ /10 ⁶ in ⁴	mm ³ /10 ³ in ³	mm in	mm ³ /10 ³ in ³	mm in	mm in	mm ⁴ /10 ³ in ⁴	mm ⁶ /10 ⁶ in ⁶	m ² /m ft ² /ft
576 387	10100 24300	22100 1350	371 14.6	25600 1560	674 1620	3280 200	95.8 3.77	5110 312	114 4.49	856 33.7	61600 148	123000 459000	3.41 11.19
527 354	9160 22000	20300 1240	368 14.5	23300 1420	608 1460	2970 181	95.0 3.74	4620 282	113 4.44	851 33.5	47900 115	110000 408000	3.39 11.11
473 318	8120 19500	18200 1110	368 14.5	20800 1270	537 1290	2640 161	94.2 3.71	4100 250	112 4.40	846 33.3	35100 84.4	95900 357000	3.36 11.03
433 291	7370 17700	16700 1020	366 14.4	19000 1160	483 1160	2390 146	93.5 3.68	3700 226	110 4.34	841 33.1	27100 65.1	85700 319000	3.33 10.94
392 263	6620 15900	15100 919	363 14.3	17000 1040	433 1040	2150 131	93.0 3.66	3310 202	109 4.31	836 32.9	20300 48.7	75500 281000	3.31 10.87
359 241	5910 14200	13600 831	358 14.1	15400 940	388 933	1930 118	91.9 3.62	2980 182	109 4.29	833 32.8	15100 36.2	67400 251000	3.31 10.86
329 221	5370 12900	12400 759	358 14.1	14000 857	350 840	1740 106	91.2 3.59	2690 164	108 4.25	828 32.6	11600 27.8	60200 224000	3.29 10.79
299 201	4830 11600	11200 686	356 14.0	12700 773	312 749	1560 95.2	90.4 3.56	2410 147	107 4.21	828 32.6	8660 20.8	53200 198000	3.27 10.73
251 169	3870 9290	9000 549	348 13.7	10300 629	129 310	883 53.9	63.5 2.50	1380 84.4	77.0 3.03	828 32.6	7370 17.7	22100 82400	2.85 9.36
226 152	3400 8160	7980 487	343 13.5	9160 559	114 273	773 47.2	62.7 2.47	1210 73.9	76.5 3.01	823 32.4	5160 12.4	19300 71700	2.85 9.34
210 141	3100 7450	7340 448	340 13.4	8420 514	102 246	700 42.7	61.7 2.43	1100 66.9	75.7 2.98	820 32.3	4040 9.70	17300 64400	2.83 9.28
193 130	2790 6710	6650 406	335 13.2	7650 467	90.7 218	621 37.9	60.7 2.39	975 59.5	74.7 2.94	818 32.2	3070 7.37	15200 56600	2.82 9.25
176 118	2460 5900	5880 359	330 13.0	6800 415	77.8 187	534 32.6	58.9 2.32	841 51.3	73.4 2.89	818 32.2	2210 5.30	13000 48300	2.81 9.23
582 391	8620 20700	20500 1250	340 13.4	23800 1450	645 1550	3240 198	93.2 3.67	5080 310	111 4.37	782 30.8	72000 173	98300 366000	3.20 10.51
531 357	7780 18700	18700 1140	338 13.3	21600 1320	579 1390	2930 179	92.5 3.64	4570 279	109 4.31	777 30.6	55800 134	87000 324000	3.18 10.43
484 326	6990 16800	17000 1040	335 13.2	19500 1190	516 1240	2650 162	91.4 3.60	4130 252	108 4.26	772 30.4	42900 103	77100 287000	3.15 10.34
434 292	6200 14900	15200 930	335 13.2	17400 1060	458 1100	2360 144	90.9 3.58	3650 223	107 4.22	767 30.2	31300 75.2	67100 250000	3.13 10.26
389 261	5450 13100	13600 829	333 13.1	15500 943	399 959	2080 127	89.7 3.53	3210 196	106 4.16	762 30.0	22500 54.1	57700 215000	3.10 10.18
350 235	4870 11700	12300 748	330 13.0	13900 847	356 855	1870 114	89.2 3.51	2870 175	105 4.13	757 29.8	16800 40.3	51000 190000	3.08 10.11
314 211	4290 10300	10900 665	328 12.9	12300 751	315 757	1640 100	88.6 3.49	2540 155	104 4.11	752 29.6	11800 28.4	44600 166000	3.06 10.05
284 191	3830 9200	9830 600	325 12.8	11100 675	280 673	1470 89.5	87.9 3.46	2260 138	103 4.06	749 29.5	8740 21.0	39200 146000	3.05 10.00
257 173	3430 8230	8870 541	323 12.7	9950 607	249 598	1310 79.8	86.9 3.42	2020 123	102 4.03	744 29.3	6490 15.6	34600 129000	3.04 9.96

VIGAS DE ALA ANCHA

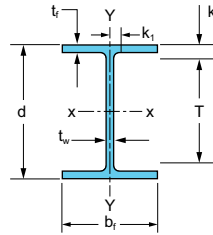

Tamaño del haz		Área A	Profundidad d	Alma		Ala		Distancia				Criterios de sección compacta		
				Espesor t _w	t _w /2	b _f	t _f	k		k ₁	T	Calibre viable	b _f /2t _f	h/t _w
								k _{des}	k _{det}					
		mm ² in ²	mm in	mm in	mm in	mm in	mm in	mm in	mm in	mm in	mm in	mm in	mm in	
W760 W30	x 220	28100	780	16.5	7.94	267	30.0	46.5	52.4	28.6	673.1	139.7	4.44	41.6
	x 148	43.6	30.7	0.650	5/16	10.5	1.18	1.83	2 1/16	1 1/8	26 1/2	5 1/2	4.44	41.6
	x 196	25000	770	15.6	7.94	267	25.4	41.9	47.6	28.6			5.27	43.9
	x 132	38.8	30.3	0.615	5/16	10.5	1.00	1.65	1 7/8	1 1/8			5.27	43.9
	x 185	23500	767	14.9	7.94	267	23.6	40.1	46.0	28.6			5.65	46.2
	x 124	36.5	30.2	0.585	5/16	10.5	0.930	1.58	1 13/16	1 1/8			5.65	46.2
	x 173	22100	762	14.4	7.94	267	21.6	38.1	44.5	28.6			6.17	47.8
x 116	34.2	30.0	0.565	5/16	10.5	0.850	1.50	1 3/4	1 1/8			6.17	47.8	
x 161	20500	757	13.8	7.94	267	19.3	35.8	42.9	28.6			6.89	49.6	
x 108	31.7	29.8	0.545	5/16	10.5	0.760	1.41	1 11/16	1 1/8			6.89	49.6	
x 147	18700	754	13.2	6.35	267	17.0	33.5	39.7	27.0			7.80	51.9	
x 99	29.0	29.7	0.520	1/4	10.5	0.670	1.32	1 9/16	1 1/16			7.80	51.9	
x 134	17000	749	11.9	6.35	264	15.5	32.0	38.1	27.0			8.52	57.5	
x 90	26.3	29.5	0.470	1/4	10.4	0.610	1.26	1 1/2	1 1/16			8.52	57.5	
W690 W27	x 802	103000	826	50.0	25.4	389	89.9	110	113	46.0	600.1	139.7	2.15	12.1
	x 539	159	32.5	1.97	1	15.3	3.54	4.33	4 7/16	1 13/16	23 5/8	5 1/2	2.15	12.1
	x 548	70300	772	35.1	17.5	373	63.0	83.1	85.7	38.1			2.96	17.3
	x 368	109	30.4	1.38	11/16	14.7	2.48	3.27	3 3/8	1 1/2			2.96	17.3
	x 500	64000	762	32.0	15.9	371	57.9	78.0	81.0	36.5			3.19	18.9
	x 336	99.2	30.0	1.26	5/8	14.6	2.28	3.07	3 3/16	1 7/16			3.19	18.9
	x 457	58200	752	29.5	15.9	366	53.1	73.2	76.2	36.5			3.46	20.6
	x 307	90.2	29.6	1.16	5/8	14.4	2.09	2.88	3	1 7/16			3.46	20.6
	x 419	53600	744	26.9	14.3	366	49.0	69.1	71.4	34.9			3.72	22.5
	x 281	83.1	29.3	1.06	9/16	14.4	1.93	2.72	2 13/16	1 3/8			3.72	22.5
	x 384	49100	737	24.9	12.7	363	45.0	65.0	68.3	33.3			4.03	24.4
	x 258	76.1	29.0	0.980	1/2	14.3	1.77	2.56	2 11/16	1 5/16			4.03	24.4
	x 350	44800	729	23.1	12.7	361	40.9	61.0	63.5	33.3			4.41	26.2
	x 235	69.4	28.7	0.910	1/2	14.2	1.61	2.40	2 1/2	1 5/16			4.41	26.2
x 323	41200	721	21.1	11.1	358	38.1	58.2	60.3	31.8			4.71	28.7	
x 217	63.9	28.4	0.830	7/16	14.1	1.50	2.29	2 3/8	1 1/4			4.71	28.7	
x 289	36800	714	19.1	9.52	356	34.0	54.1	57.2	30.2			5.24	31.8	
x 194	57.1	28.1	0.750	3/8	14.0	1.34	2.13	2 1/4	1 3/16			5.24	31.8	
x 265	33900	706	18.4	9.52	358	30.2	50.3	52.4	30.2			5.92	32.9	
x 178	52.5	27.8	0.725	3/8	14.1	1.19	1.98	2 1/16	1 3/16			5.92	32.9	
x 240	30700	701	16.8	9.52	356	27.4	47.5	50.8	30.2			6.49	36.1	
x 161	47.6	27.6	0.660	3/8	14.0	1.08	1.87	2	1 3/16			6.49	36.1	
x 217	27900	696	15.4	7.94	356	24.8	44.7	47.6	28.6			7.16	39.4	
x 146	43.2	27.4	0.605	5/16	14.0	0.975	1.76	1 7/8	1 1/8			7.16	39.4	
W690 W27	x 192	24400	701	15.5	7.94	254	27.9	43.2	50.8	28.6	600.1	139.7	4.55	39.7
	x 129	37.8	27.6	0.610	5/16	10.0	1.10	1.70	2	1 1/8	23 5/8	5 1/2	4.55	39.7
	x 170	21700	693	14.5	7.94	257	23.6	38.9	46.0	28.6			5.41	42.5
	x 114	33.6	27.3	0.570	5/16	10.1	0.930	1.53	1 13/16	1 1/8			5.41	42.5
	x 152	19400	688	13.1	6.35	254	21.1	36.3	44.5	27.0			6.03	47.1
x 102	30.0	27.1	0.515	1/4	10.0	0.830	1.43	1 3/4	1 1/16			6.03	47.1	
x 140	17800	683	12.4	6.35	254	18.9	34.0	41.3	27.0			6.70	49.5	
x 94	27.6	26.9	0.490	1/4	10.0	0.745	1.34	1 5/8	1 1/16			6.70	49.5	
x 125	15900	678	11.7	6.35	254	16.3	31.5	39.7	27.0			7.78	52.7	
x 84	24.7	26.7	0.460	1/4	10.0	0.640	1.24	1 9/16	1 1/16			7.78	52.7	

PERFILES ESTRUCTURALES

VIGAS DE ALA ANCHA

Peso nominal	Eje X-X				Eje Y-Y				rts	ho	Propiedades de torsión		Área de revestimiento
	I	S	r	Z	I	S	r	Z			J	Cw	
kg/m lb/ft	mm ⁴ /10 ⁶ in ⁴	mm ³ /10 ³ in ³	mm in	in ³ mm ³ /10 ³	mm ⁴ /10 ⁶ in ⁴	mm ³ /10 ³ in ³	mm in	mm ³ /10 ³ in ³	mm in	mm in	mm ⁴ /10 ³ in ⁴	mm ⁶ /10 ⁶ in ⁶	m ² /m ft ² /ft
220 148	2780 6680	7140 436	315 12.4	8190 500	94.5 227	710 43.3	579 2.28	1110 68.0	70.4 2.77	749 29.5	6040 14.5	13300 49400	2.59 8.51
196 132	2400 5770	6230 380	310 12.2	7160 437	81.6 196	610 37.2	57.2 2.25	957 58.4	69.8 2.75	744 29.3	4050 9.72	11300 42100	2.57 8.45
185 124	2230 5360	5820 355	307 12.1	6690 408	75.3 181	564 34.4	56.6 2.23	885 54.0	69.3 2.73	744 29.3	3330 799	10400 38600	2.57 8.44
173 116	2050 4930	5390 329	305 12.0	6190 378	68.3 164	513 31.3	55.6 2.19	806 49.2	68.6 2.70	742 29.2	2680 6.43	9370 34900	2.56 8.41
161 108	1860 4470	4900 299	302 11.9	5670 346	60.8 146	457 27.9	54.6 2.15	719 43.9	67.8 2.67	737 29.0	2080 4.99	8300 30900	2.55 8.38
147 99	1660 3990	4410 269	297 11.7	5110 312	53.3 128	401 24.5	53.3 2.10	633 38.6	66.5 2.62	737 29.0	1570 3.77	7200 26800	2.55 8.36
134 90	1500 3610	4010 245	297 11.7	4640 283	479 115	362 22.1	53.1 2.09	569 34.7	66.0 2.60	734 28.9	1180 2.84	6440 24000	2.53 8.31
802 539	10700 25600	25700 1570	323 12.7	31000 1890	878 2110	4540 277	92.7 3.65	7160 437	112 4.41	737 29.0	206000 496	119000 443000	3.11 10.19
548 368	6740 16200	17400 1060	310 12.2	20300 1240	545 1310	2930 179	88.4 3.48	4570 279	105 4.15	709 27.9	70800 170	68500 255000	2.97 9.74
500 336	6080 14600	15900 972	307 12.1	18500 1130	491 1180	2650 162	87.6 3.45	4130 252	104 4.10	704 27.7	54500 131	60700 226000	2.94 9.66
457 307	5450 13100	14500 887	305 12.0	16900 1030	437 1050	2390 146	86.6 3.41	3720 227	103 4.04	698 27.5	42000 101	53400 199000	2.91 9.54
419 281	4950 11900	13300 814	305 12.0	15300 936	397 953	2180 133	86.1 3.39	3380 206	102 4.00	696 27.4	33100 79.5	47800 178000	2.90 9.51
384 258	4500 10800	12200 745	302 11.9	14000 852	358 859	1970 120	85.3 3.36	3060 187	101 3.96	691 27.2	25600 61.6	42700 159000	2.88 9.44
350 235	4040 9700	11100 677	300 11.8	12700 772	320 769	1770 108	84.6 3.33	2750 168	99.6 3.92	688 27.1	19600 47.0	37900 141000	2.85 9.37
323 217	3710 8910	10300 627	300 11.8	11700 711	293 704	1640 100	84.3 3.32	2520 154	98.8 3.89	683 26.9	15700 37.6	34400 128000	2.83 9.30
289 194	3270 7860	9160 559	297 11.7	10300 631	258 619	1440 88.1	83.6 3.29	2230 136	97.8 3.85	681 26.8	11300 27.1	29800 111000	2.81 9.23
265 178	2920 7020	8280 505	295 11.6	9340 570	231 555	1290 78.8	82.6 3.25	2000 122	97.3 3.83	676 26.6	8370 20.1	26400 98400	2.81 9.21
240 161	2630 6310	7510 458	292 11.5	8440 515	207 497	1160 70.9	82.0 3.23	1790 109	96.3 3.79	673 26.5	6290 15.1	23400 87300	2.79 9.16
217 146	2360 5660	6780 414	292 11.5	7600 464	184 443	1040 63.5	81.3 3.20	1600 97.7	95.5 3.76	671 26.4	4700 11.3	20700 77200	2.78 9.13
192 129	1980 4760	5650 345	284 11.2	6470 395	76.6 184	603 36.8	56.1 2.21	944 57.6	67.6 2.66	673 26.5	4620 11.1	8730 32500	2.39 7.83
170 114	1700 4080	4900 299	279 11.0	5620 343	66.2 159	516 31.5	55.4 2.18	808 49.3	67.3 2.65	671 26.4	3050 7.33	7410 27600	2.38 7.82
152 102	1510 3620	4380 267	279 11.0	5000 305	579 139	456 27.8	54.6 2.15	711 43.4	66.5 2.62	668 26.3	2200 5.28	6440 24000	2.37 7.76
140 94	1360 3270	3980 243	277 10.9	4560 278	51.6 124	406 24.8	53.8 2.12	636 38.8	65.8 2.59	665 26.2	1680 4.03	5720 21300	2.36 7.74
125 84	1190 2850	3490 213	272 10.7	4000 244	44.1 106	347 21.2	52.6 2.07	544 33.2	64.5 2.54	663 26.1	1170 2.81	4810 17900	2.35 7.71

VIGAS DE ALA ANCHA

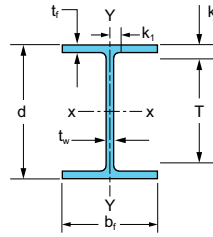

Tamaño del haz		Área A	Profundidad d	Alma		Ala		Distancia				Criterios de sección compacta		
				Espesor t_w	t_w/2	b_f	t_f	k		k_1	T			Calibre viable
								k_des	k_det			mm	mm	
W610	x 551	70300	711	38.6	19.0	348	691	81.8	92.1	39.7	5271	139.7	2.51	14.2
W24	x 370	109	28.0	1.52	¾	13.7	2.72	3.22	3 5/8	19/16	20 ¾	5 ½	2.51	14.2
	x 498	63400	699	35.1	17.5	343	63.0	75.7	85.7	38.1			2.73	15.6
	x 335	98.3	27.5	1.38	11/16	13.5	2.48	2.98	3 3/8	1 ½			2.73	15.6
	x 455	57900	688	32.0	15.9	340	57.9	70.6	81.0	36.5			2.94	17.1
	x 306	89.7	27.1	1.26	5/8	13.4	2.28	2.78	3 3/16	17/16			2.94	17.1
	x 415	52800	678	29.5	15.9	338	53.1	65.8	76.2	36.5			3.18	18.6
	x 279	81.9	26.7	1.16	5/8	13.3	2.09	2.59	3	17/16			3.18	18.6
	x 372	47400	668	26.4	14.3	335	48.0	60.7	71.4	34.9			3.49	20.7
	x 250	73.5	26.3	1.04	9/16	13.2	1.89	2.39	2 13/16	13/8			3.49	20.7
	x 341	43400	660	24.4	12.7	333	43.9	56.6	66.7	33.3			3.79	22.5
	x 229	67.2	26.0	0.960	½	13.1	1.73	2.23	2 5/8	15/16			3.79	22.5
	x 307	39200	653	22.1	11.1	330	39.9	52.6	63.5	31.8			4.14	24.8
	x 207	60.7	25.7	0.870	7/16	13.0	1.57	2.07	2 ½	1 ¼			4.14	24.8
	x 285	36500	648	20.6	11.1	330	37.1	49.8	60.3	31.8			4.43	26.6
	x 192	56.5	25.5	0.810	7/16	13.0	1.46	1.96	2 3/8	1 ¼			4.43	26.6
	x 262	33400	640	19.1	9.52	328	34.0	46.7	57.2	30.2			4.81	28.7
	x 176	51.7	25.2	0.750	3/8	12.9	1.34	1.84	2 ¼	13/16			4.81	28.7
	x 241	30800	635	17.9	9.52	330	31.0	43.7	54.0	30.2			5.31	30.6
	x 162	47.8	25.0	0.705	3/8	13.0	1.22	1.72	2 1/8	13/16			5.31	30.6
	x 217	27700	627	16.5	7.94	328	27.7	40.4	50.8	28.6			5.92	33.2
	x 146	43.0	24.7	0.650	5/16	12.9	1.09	1.59	2	11/8			5.92	33.2
	x 195	24900	622	15.4	7.94	328	24.4	37.1	47.6	28.6			6.70	35.6
	x 131	38.6	24.5	0.605	5/16	12.9	0.960	1.46	17/8	11/8			6.70	35.6
	x 174	22200	617	14.0	7.94	325	21.6	34.3	44.5	28.6			7.53	39.2
	x 117	34.4	24.3	0.550	5/16	12.8	0.850	1.35	1 ¾	11/8			7.53	39.2
	x 155	19800	612	12.7	6.35	325	19.1	31.8	41.3	27.0			8.50	43.1
	x 104	30.7	24.1	0.500	¼	12.8	0.750	1.25	15/8	11/16			8.50	43.1
W610	x 153	19500	622	14.0	7.94	229	24.9	37.6	47.6	28.6	5271	139.7	4.59	39.2
W24	x 103	30.3	24.5	0.550	5/16	9.00	0.980	1.48	17/8	11/8	20 ¾	5 ½	4.59	39.2
	x 140	17900	617	13.1	6.35	230	22.2	35.1	44.5	27.0			5.18	41.9
	x 94	27.7	24.3	0.515	¼	9.07	0.875	1.38	1 ¾	11/16			5.18	41.9
	x 125	15900	612	11.9	6.35	229	19.6	32.3	42.9	27.0			5.86	45.9
	x 84	24.7	24.1	0.470	¼	9.02	0.770	1.27	11/16	11/16			5.86	45.9
	x 113	14500	607	11.2	6.35	228	17.3	30.0	39.7	27.0			6.61	49.0
	x 76	22.4	23.9	0.440	¼	8.99	0.680	1.18	19/16	11/16			6.61	49.0
	x 101	13000	602	10.5	6.35	228	14.9	27.7	38.1	27.0			7.66	52.0
	x 68	20.1	23.7	0.415	¼	8.97	0.585	1.09	1 ½	11/16			7.66	52.0
W610	x 92	11700	602	10.9	6.35	179	15.0	27.7	38.1	27.0	5271	88.9	5.97	50.1
W24	x 62	18.2	23.7	0.430	¼	7.04	0.590	1.09	1 ½	11/16	20 ¾	3 ½	5.97	50.1
	x 82	10500	599	10.0	4.76	178	12.8	25.7	36.5	25.4	5271	88.9	6.94	54.6
	x 55	16.2	23.6	0.395	3/16	7.01	0.505	1.01	17/16	1	20 ¾	3 ½	6.94	54.6
W530	x 300	38300	584	23.1	12.7	320	41.4	54.1	63.5	33.3	457.2	139.7	3.86	20.6
W21	x 201	59.3	23.0	0.910	1/2	12.6	1.63	2.13	2 ½	15/16	18	5 ½	3.86	20.6
	x 272	34600	577	21.1	11.1	318	37.6	50.3	60.3	31.8			4.22	22.6
	x 182	53.6	22.7	0.830	7/16	12.5	1.48	1.98	2 3/8	1 ¼			4.22	22.6
	x 248	31500	572	19.1	9.52	315	34.5	47.2	57.2	30.2			4.57	25.0
	x 166	48.8	22.5	0.750	3/8	12.4	1.36	1.86	2 ¼	13/16			4.57	25.0
	x 219	27900	561	18.3	9.52	318	29.2	41.9	50.8	30.2			5.44	26.1
	x 147	43.2	22.1	0.720	3/8	12.5	1.15	1.65	2	13/16			5.44	26.1
	x 196	25000	554	16.5	7.94	315	26.4	39.1	49.2	28.6			6.01	28.9
	x 132	38.8	21.8	0.650	5/16	12.4	1.04	1.54	115/16	11/8			6.01	28.9
	x 182	23200	551	15.2	7.94	315	24.4	37.1	46.0	28.6			6.45	31.3
	x 122	35.9	21.7	0.600	5/16	12.4	0.960	1.46	113/16	11/8			6.45	31.3
	x 165	21000	546	14.0	7.94	312	22.2	35.1	44.5	28.6			7.05	34.1
	x 111	32.6	21.5	0.550	5/16	12.3	0.875	1.38	1 ¾	11/8			7.05	34.1
	x 150	19200	544	12.7	6.35	312	20.3	33.0	42.9	27.0			7.68	37.5
	x 101	29.8	21.4	0.500	¼	12.3	0.800	1.30	111/16	11/16			7.68	37.5

PERFILES ESTRUCTURALES
VIGAS DE ALA ANCHA

Peso nominal	Eje X-X				Eje Y-Y				rts	ho	Propiedades de torsión		Área de revestimiento
	I	S	r	Z	I	S	r	Z			J	Cw	
kg/m lb/ft	mm ⁴ /10 ⁶ in ⁴	mm ³ /10 ³ in ³	mm in	in ³ mm ³ /10 ³	mm ⁴ /10 ⁶ in ⁴	mm ³ /10 ³ in ³	mm in	mm ³ /10 ³ in ³	mm in	mm in	mm ⁴ /10 ³ in ⁴	mm ⁶ /10 ⁶ in ⁶	m ² /m ft ² /ft
551 370	5580 13400	15700 957	282 11.1	18500 1130	483 1160	2790 170	83.1 3.27	4380 267	99.6 3.92	643 25.3	83700 201	49900 186000	2.74 8.98
498 335	4950 11900	14200 864	279 11.0	16700 1020	429 1030	2490 152	82.0 3.23	3900 238	98.0 3.86	635 25.0	63300 152	43200 161000	2.70 8.85
455 306	4450 10700	12900 789	277 10.9	15100 922	383 919	2250 137	81.3 3.20	3510 214	96.8 3.81	630 24.8	48700 117	38100 142000	2.67 8.77
415 279	4000 9600	11800 718	274 10.8	13700 835	343 823	2030 124	80.5 3.17	3160 193	95.5 3.76	625 24.6	37700 90.5	33600 125000	2.65 8.69
372 250	3530 8490	10600 644	272 10.7	12200 744	301 724	1800 110	79.8 3.14	2800 171	94.2 3.71	620 24.4	27700 66.6	29000 108000	2.62 8.61
341 229	3180 7650	9640 588	272 10.7	11100 675	271 651	1630 99.4	79.0 3.11	2520 154	93.2 3.67	617 24.3	21400 51.3	25800 96100	2.60 8.54
307 207	2840 6820	8700 531	269 10.6	9930 606	241 578	1460 88.8	78.2 3.08	2250 137	91.9 3.62	612 24.1	15900 38.3	22600 84100	2.58 8.47
285 192	2610 6260	8050 491	267 10.5	9160 559	221 530	1340 81.8	78.0 3.07	2060 126	91.4 3.6	610 24.0	12800 30.8	20500 76300	2.58 8.45
262 176	2360 5680	7370 450	267 10.5	8370 511	199 479	1220 74.3	77.2 3.04	1880 115	90.7 3.57	607 23.9	9950 23.9	18400 68400	2.55 8.38
241 162	2150 5170	6780 414	264 10.4	7670 468	184 443	1120 68.4	77.5 3.05	1720 105	90.7 3.57	605 23.8	7700 18.5	16800 62600	2.55 8.38
217 146	1910 4580	6080 371	262 10.3	6850 418	163 391	991 60.5	76.5 3.01	1530 93.2	89.7 3.53	599 23.6	5580 13.4	14700 54600	2.53 8.31
195 131	1670 4020	5390 329	259 10.2	6060 370	142 340	869 53.0	75.4 2.97	1340 81.5	88.6 3.49	597 23.5	3950 9.50	12600 47100	2.52 8.28
174 117	1470 3540	4770 291	257 10.1	5360 327	124 297	762 46.5	74.7 2.94	1170 71.4	87.9 3.46	597 23.5	2800 6.72	11000 40800	2.51 8.23
155 104	1290 3100	4230 258	257 10.1	4740 289	108 259	667 40.7	73.9 2.91	1020 62.4	86.9 3.42	594 23.4	1960 4.72	9450 35200	2.50 8.20
153 103	1250 3000	4010 245	254 10.0	4590 280	49.5 119	434 26.5	50.5 1.99	680 41.5	61.0 2.40	597 23.5	2940 7.07	4460 16600	2.13 6.99
140 94	1120 2700	3640 222	251 9.87	4160 254	45.4 109	393 24.0	50.3 1.98	615 37.5	61.0 2.40	594 23.4	2190 5.26	4030 15000	2.13 6.99
125 84	986 2370	3210 196	249 9.79	3670 224	39.3 94.4	342 20.9	49.5 1.95	534 32.6	60.2 2.37	592 23.3	1540 3.70	3440 12800	2.12 6.95
113 76	874 2100	2880 176	246 9.69	3280 200	34.3 82.5	302 18.4	48.8 1.92	469 28.6	59.2 2.33	589 23.2	1120 2.68	2980 11100	2.11 6.91
101 68	762 1830	2520 154	243 9.55	2900 177	29.3 70.4	257 15.7	47.5 1.87	401 24.5	58.4 2.30	587 23.1	778 1.87	2530 9430	2.09 6.87
92 62	645 1550	2150 131	234 9.23	2510 153	14.4 34.5	161 9.80	35.1 1.38	257 15.7	44.4 1.75	587 23.1	712 1.71	1240 4620	1.90 6.23
82 55	562 1350	1870 114	231 9.11	2200 134	12.1 29.1	136 8.30	34.0 1.34	218 13.3	43.7 1.72	587 23.1	491 1.18	1040 3870	1.89 6.20
300 201	2210 5310	7550 461	241 9.47	8690 530	226 542	1410 86.1	76.7 3.02	2180 133	90.2 3.55	544 21.4	17000 40.9	16600 62000	2.40 7.88
272 182	1970 4730	6830 417	239 9.40	7800 476	201 483	1270 77.2	76.2 3.00	1950 119	89.2 3.51	538 21.2	12800 30.7	14600 54400	2.38 7.81
248 166	1780 4280	6230 380	238 9.36	7080 432	181 435	1150 70.0	75.9 2.99	1770 108	88.4 3.48	536 21.1	9820 23.6	13000 48500	2.36 7.76
219 147	1510 3630	5390 329	233 9.17	6110 373	157 376	985 60.1	74.9 2.95	1520 92.6	87.9 3.46	533 21.0	6410 15.4	11000 41100	2.36 7.73
196 132	1340 3220	4830 295	232 9.12	5460 333	139 333	877 53.5	74.4 2.93	1350 82.3	87.1 3.43	528 20.8	4700 11.3	9670 36000	2.33 7.66
182 122	1230 2960	4470 273	231 9.09	5030 307	127 305	806 49.2	74.2 2.92	1240 75.6	86.4 3.40	526 20.7	3740 8.98	8780 32700	2.33 7.65
165 111	1110 2670	4080 249	230 9.05	4570 279	114 274	729 44.5	73.7 2.90	1120 68.2	85.6 3.37	523 20.6	2840 6.83	7840 29200	2.31 7.59
150 101	1010 2420	3720 227	229 9.02	4150 253	103 248	660 40.3	73.4 2.89	1010 61.7	85.1 3.35	523 20.6	2170 5.21	7040 26200	2.31 7.58

VIGAS DE ALA ANCHA

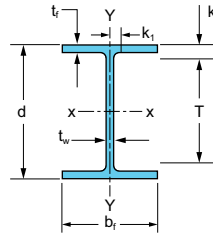

Tamaño del haz		Área A	Profundidad d	Alma		Ala		Distancia				Criterios de sección compacta		
				Espesor t _w	t _w /2	b _f	t _f	k		k ₁	T	Calibre viable	b _f /2t _f	h/t _w
								k _{des}	k _{det}					
mm ² in ²	mm in	mm in	mm in	mm in	mm in	mm in	mm in	mm in	mm in	mm in	mm in	mm in	mm in	
W530 W21	x 138	17600	549	14.7	7.94	214	23.6	36.3	41.3	23.8	466.7	139.7	4.53	32.3
	x 93	27.3	21.6	0.580	5/16	8.42	0.930	1.43	1 5/8	15/16	18 3/8	5 1/2	4.53	32.3
	x 123	15700	544	13.1	6.35	212	21.2	34.0	38.1	22.2			5.00	36.4
	x 83	24.4	21.4	0.515	1/4	8.36	0.835	1.34	1 1/2	7/8			5.00	36.4
	x 109	13900	538	11.6	6.35	211	18.8	31.5	36.5	22.2			5.60	41.2
	x 73	21.5	21.2	0.455	1/4	8.30	0.740	1.24	1 7/16	7/8			5.60	41.2
	x 101	12900	536	10.9	6.35	210	17.4	30.2	34.9	22.2			6.04	43.6
x 68	20.0	21.1	0.430	1/4	8.27	0.685	1.19	1 3/8	7/8			6.04	43.6	
x 92	11800	53	10.2	4.76	209	15.	28.4	33.3	20.6			6.70	46.9	
x 62	18.3	21.0	0.400	3/16	8.24	0.615	1.12	1 5/16	13/16			6.70	46.9	
x 82	10500	528	9.53	4.76	209	13.3	25.9	30.2	20.6			7.87	50.0	
x 55	16.2	20.8	0.375	3/16	8.22	0.522	1.02	1 3/16	13/16			7.87	50.0	
x 72	9100	523	8.89	4.76	207	10.9	23.6	28.6	20.6			9.47	53.6	
x 48	14.1	20.6	0.350	3/16	8.14	0.430	0.930	1 1/8	13/16			9.47	53.6	
W530 W21	x 85	10800	536	10.3	4.76	167	16.5	29.2	33.3	20.6	466.7	88.9	5.04	46.3
	x 57	16.7	21.1	0.405	3/16	6.56	0.650	1.15	1 5/16	13/16	18 3/8	3 1/2	5.04	46.3
	x 74	9480	528	9.65	4.76	166	13.6	26.4	31.8	20.6			6.10	49.4
x 50	14.7	20.8	0.380	3/16	6.53	0.535	1.04	1 1/4	13/16			6.10	49.4	
x 66	8390	526	8.89	4.76	165	11.4	24.1	28.6	20.6			7.22	53.6	
x 44	13.0	20.7	0.350	3/16	6.50	0.450	0.950	1 1/8	13/16			7.22	53.6	
W460 W18	x 464	59100	566	38.6	19.0	305	69.6	82.3	87.3	34.9	393.7	139.7	2.19	10.4
	x 311	91.6	22.3	1.52	3/4	12.0	2.74	3.24	3 7/16	1 3/8	15 1/2	5 1/2	2.19	10.4
	x 421	53700	556	35.6	17.5	302	63.5	76.2	81.0	33.3			2.38	11.3
	x 283	83.3	21.9	1.40	11/16	11.9	2.50	3.00	3 3/16	1 5/16			2.38	11.3
	x 384	49000	546	32.5	15.9	300	58.4	68.6	76.2	31.8			2.56	12.5
	x 258	76.0	21.5	1.28	5/8	11.8	2.30	2.70	3	1 1/4			2.56	12.5
	x 349	44300	536	29.5	15.9	297	53.6	63.8	69.9	30.2			2.76	13.8
	x 234	68.6	21.1	1.16	5/8	11.7	2.11	2.51	2 3/4	1 3/16			2.76	13.8
	x 315	40200	526	26.9	14.3	295	48.5	58.7	65.1	30.2			3.02	15.1
	x 211	62.3	20.7	1.06	9/16	11.6	1.91	2.31	2 9/16	1 3/16			3.02	15.1
	x 286	36300	518	24.4	12.7	292	44.5	54.6	61.9	28.6			3.27	16.7
	x 192	56.2	20.4	0.960	1/2	11.5	1.75	2.15	2 7/16	1 1/8			3.27	16.7
	x 260	33200	508	22.6	11.1	290	40.4	50.5	61.9	31.8			3.58	18.0
	x 175	51.4	20.0	0.890	7/16	11.4	1.59	1.99	2 7/16	1 1/4	384.2	15 1/8	3.58	18.0
	x 235	29900	500	20.6	11.1	287	36.6	46.7	60.3	31.8			3.92	19.8
x 158	46.3	19.7	0.810	7/16	11.3	1.44	1.84	2 3/8	1 1/4			3.92	19.8	
x 213	27100	495	18.5	9.52	284	33.5	43.7	55.6	30.2			4.25	22.0	
x 143	42.0	19.5	0.730	3/8	11.2	1.32	1.72	2 3/16	1 3/16			4.25	22.0	
x 193	24700	490	17.0	9.52	284	30.5	40.6	52.4	30.2			4.65	23.9	
x 130	38.3	19.3	0.670	3/8	11.2	1.20	1.60	2 1/16	1 3/16			4.65	23.9	
x 177	22600	483	16.6	7.94	287	26.9	37.1	49.2	30.2			5.31	24.5	
x 119	35.1	19.0	0.655	5/16	11.3	1.06	1.46	1 15/16	1 3/16			5.31	24.5	
x 158	20100	475	15.0	7.94	284	23.9	34.0	46.0	28.6			5.96	27.2	
x 106	31.1	18.7	0.590	5/16	11.2	0.940	1.34	1 113/16	1 1/8			5.96	27.2	
x 144	18400	472	13.6	7.94	282	22.1	32.3	44.5	28.6			6.41	30.0	
x 97	28.5	18.6	0.535	5/16	11.1	0.870	1.27	1 1/4	1 1/8			6.41	30.0	
x 128	16300	467	12.2	6.35	282	19.6	29.7	41.3	27.0			7.20	33.4	
x 86	25.3	18.4	0.480	1/4	11.1	0.770	1.17	1 5/8	1 1/16			7.20	33.4	
x 113	14400	462	10.8	6.35	279	17.3	27.4	39.7	27.0			8.11	37.8	
x 76	22.3	18.2	0.425	1/4	11.0	0.680	1.08	1 9/16	1 1/16			8.11	37.8	

PERFILES ESTRUCTURALES
VIGAS DE ALA ANCHA

Peso nominal	Eje X-X				Eje Y-Y				rts	ho	Propiedades de torsión		Área de revestimiento
	I	S	r	Z	I	S	r	Z			J	Cw	
kg/m lb/ft	mm ⁴ /10 ⁶ in ⁴	mm ³ /10 ³ in ³	mm in	in ³ mm ³ /10 ³	mm ⁴ /10 ⁶ in ⁴	mm ³ /10 ³ in ³	mm in	mm ³ /10 ³ in ³	mm in	mm in	mm ⁴ /10 ³ in ⁴	mm ⁶ /10 ⁶ in ⁶	m ² /m ft ² /ft
138 93	862 2070	3150 192	221 8.70	3620 221	38.7 92.9	362 22.1	46.7 1.84	569 34.7	56.9 2.24	526 20.7	2510 6.03	2670 9940	1.92 6.31
123 83	762 1830	2800 171	220 8.67	3210 196	33.9 81.4	320 19.5	46.5 1.83	500 30.5	56.1 2.21	523 20.6	1810 4.34	2320 8630	1.91 6.27
109 73	666 1600	2470 151	219 8.64	2820 172	29.4 70.6	279 17.0	46.0 1.81	436 26.6	55.6 2.19	521 20.5	1260 3.02	1990 7410	1.90 6.22
101 68	616 1480	2290 140	218 8.60	2620 160	26.9 64.7	257 15.7	45.7 1.80	400 24.4	55.1 2.17	518 20.4	1020 2.45	1820 6760	1.89 6.20
92 62	554 1330	2080 127	217 8.54	2360 144	23.9 57.5	229 14.0	45.0 1.77	356 21.7	54.6 2.15	518 20.4	762 1.83	1600 5960	1.88 6.18
82 55	475 1140	1800 110	213 8.40	2060 126	20.1 48.4	193 11.8	43.9 1.73	302 18.4	53.6 2.11	515 20.3	516 1.24	1340 4980	1.87 6.14
72 48	399 959	1520 93.0	209 8.24	1750 107	16.1 38.7	156 9.52	42.2 1.66	244 14.9	52.1 2.05	513 20.2	334 0.803	1060 3950	1.86 6.09
85 57	487 1170	1820 111	212 8.36	2110 129	12.7 30.6	153 9.35	34.3 1.35	243 14.8	42.7 1.68	521 20.5	737 1.77	857 3190	1.72 5.64
74 50	410 984	1550 94.5	208 8.18	1800 110	10.4 24.9	125 7.64	33.0 1.30	200 12.2	41.7 1.64	516 20.3	475 1.14	690 2570	1.70 5.58
66 44	351 843	1340 81.6	205 8.06	1560 95.4	8.62 20.7	104 6.37	32.0 1.26	167 10.2	40.6 1.60	516 20.3	320 0.770	567 2110	1.69 5.56
464 311	2900 6970	10200 624	221 8.72	12400 754	331 795	2160 132	74.9 2.95	3390 207	89.7 3.53	498 19.6	73300 176	20500 76200	2.27 7.46
421 283	2570 6170	9260 565	219 8.61	11100 676	293 704	1930 118	73.9 2.91	3030 185	88.1 3.47	493 19.4	55800 134	17700 65900	2.25 7.38
384 258	2290 5510	8420 514	217 8.53	10000 611	261 628	1750 107	73.2 2.88	2720 166	86.9 3.42	488 19.2	42900 103	15500 57600	2.23 7.30
349 234	2040 4900	7640 466	214 8.44	9000 549	232 558	1570 95.8	72.4 2.85	2440 149	85.6 3.37	483 19.0	32800 78.7	13500 50100	2.20 7.22
315 211	1800 4330	6870 419	212 8.35	8030 490	205 493	1400 85.3	71.6 2.82	2160 132	84.3 3.32	478 18.8	24400 58.6	11700 43400	2.18 7.14
286 192	1610 3870	6230 380	210 8.28	7240 442	183 440	1260 76.8	70.9 2.79	1950 119	83.3 3.28	475 18.7	18600 44.7	10200 38000	2.16 7.07
260 175	1440 3450	5640 344	208 8.20	6520 398	163 391	1130 68.8	70.1 2.76	1740 106	82.3 3.24	467 18.4	14100 33.8	8940 33300	2.13 6.99
235 158	1270 3060	5080 310	206 8.12	5830 356	144 347	1010 61.4	69.6 2.74	1550 94.8	81.3 3.20	465 18.3	10500 25.2	7790 29000	2.11 6.92
213 143	1140 2750	4620 282	205 8.09	5280 322	129 311	909 55.5	69.1 2.72	1400 85.4	80.5 3.17	462 18.2	7990 19.2	6900 25700	2.09 6.86
193 130	1020 2460	4200 256	204 8.03	4750 290	116 278	818 49.9	68.6 2.70	1260 76.7	79.5 3.13	460 18.1	6040 14.5	6100 22700	2.08 6.84
177 119	912 2190	3790 231	201 7.90	4290 262	105 253	736 44.9	68.3 2.69	1130 69.1	79.5 3.13	455 17.9	4410 10.6	5450 20300	2.08 6.82
158 106	795 1910	3340 204	199 7.84	3770 230	91.6 220	646 39.4	67.6 2.66	991 60.5	78.7 3.10	452 17.8	3110 7.48	4670 17400	2.06 6.75
144 97	728 1750	3080 188	199 7.82	3460 211	83.7 201	592 36.1	67.3 2.65	906 55.3	78.2 3.08	450 17.7	2440 5.86	4240 15800	2.05 6.71
128 86	637 1530	2720 166	197 7.77	3050 186	72.8 175	518 31.6	66.8 2.63	793 48.4	77.5 3.05	447 17.6	1710 4.10	3650 13600	2.04 6.69
113 76	554 1330	2390 146	196 7.73	2670 163	63.3 152	452 27.6	66.3 2.61	692 42.2	76.7 3.02	444 17.5	1180 2.83	3140 11700	2.02 6.63

VIGAS DE ALA ANCHA

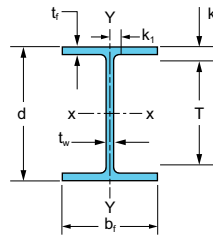

Tamaño del haz		Área A	Profundidad d	Alma		Ala		Distancia				Criterios de sección compacta		
				Espesor t _w	t _w /2	b _f	t _f	k		k ₁	T	Calibre viable	b _f /2t _f	h/t _w
								k _{des}	k _{det}					
mm ² in ²	mm in	mm in	mm in	mm in	mm in	mm in	mm in	mm in	mm in	mm in	mm in	mm in	mm in	
W460 W18	x 106	13500	470	12.6	6.35	194	20.6	30.7	38.1	22.2	393.7	88.9	4.71	32.4
	x 71	20.9	18.5	0.495	¼	764	0.810	1.21	1 ½	7/8	15 ½	3 ½	4.71	32.4
	x 97	12300	467	11.4	6.35	193	19.1	29.2	36.5	22.2			5.06	35.7
	x 65	19.1	18.4	0.450	¼	759	0.750	1.15	1 7/16	7/8			5.06	35.7
	x 89	11400	462	10.5	6.35	192	17.7	27.9	34.9	20.6			5.44	38.7
x 60	17.6	18.2	0.415	¼	756	0.695	1.10	1 3/8	13/16			5.44	38.7	
W460 W18	x 82	10500	460	9.91	4.76	191	16.0	26.2	33.3	20.6			5.98	41.1
	x 55	16.2	18.1	0.390	3/16	753	0.630	1.03	1 5/16	13/16			5.98	41.1
	x 74	9480	457	9.02	4.76	191	14.5	24.7	31.8	20.6			6.57	45.2
	x 50	14.7	18.0	0.355	3/16	750	0.570	0.972	1 ¼	13/16			6.57	45.2
	x 68	8710	460	9.14	4.76	154	15.4	25.7	31.8	20.6	393.7	88.9	5.01	44.6
x 46	13.5	18.1	0.360	3/16	6.06	0.605	1.01	1 ¼	13/16	15 ½	3 ½	5.01	44.6	
W460 W18	x 60	7610	455	8.00	4.76	153	13.3	23.5	30.2	20.6			5.73	50.9
	x 40	11.8	17.9	0.315	3/16	6.02	0.525	0.927	1 3/16	13/16			5.73	50.9
	x 52	6650	450	7.62	4.76	152	10.8	21.0	28.6	19.1			7.06	53.5
x 35	10.3	17.7	0.300	3/16	6.00	0.425	0.827	1 1/8	¾			7.06	53.5	
W410 W16	x 149	19000	432	14.9	7.94	264	25.0	35.3	47.6	28.6	333.4	139.7	5.29	24.3
	x 100	29.4	17.0	0.585	5/16	10.4	0.985	1.39	1 7/8	1 1/8	13 ¾	5 ½	5.29	24.3
	x 132	16900	427	13.3	6.35	264	22.2	32.5	44.5	27.0			5.92	27.0
	x 89	26.2	16.8	0.525	¼	10.4	0.875	1.28	1 ¾	1 1/16			5.92	27.0
W410 W16	x 114	14600	419	11.6	6.35	262	19.3	29.5	41.3	27.0			6.77	31.2
	x 77	22.6	16.5	0.455	¼	10.3	0.760	1.16	1 5/8	1 1/16			6.77	31.2
	x 100	12600	414	10.0	4.76	259	16.9	27.2	39.7	25.4			7.70	35.9
	x 67	19.6	16.3	0.395	3/16	10.2	0.665	1.07	1 9/16	1			7.70	35.9
W410 W16	x 85	10800	417	10.9	6.35	181	18.2	28.4	34.9	22.2	346.1	88.9	4.98	33.0
	x 57	16.8	16.4	0.430	¼	7.12	0.715	1.12	1 3/8	7/8	13 5/8	3 ½	4.98	33.0
	x 75	9480	414	9.65	4.76	180	16.0	26.2	33.3	20.6			5.61	37.4
	x 50	14.7	16.3	0.380	3/16	7.07	0.630	1.03	1 5/16	13/16			5.61	37.4
	x 67	8580	409	8.76	4.76	179	14.4	24.6	31.8	20.6			6.23	41.1
x 45	13.3	16.1	0.345	3/16	7.04	0.565	0.967	1 ¼	13/16			6.23	41.1	
W410 W16	x 60	7610	406	7.75	4.76	178	12.8	23.0	30.2	20.6			6.93	46.5
	x 40	11.8	16.0	0.305	3/16	7.00	0.505	0.907	1 3/16	13/16			6.93	46.5
	x 53	6840	404	7.49	4.76	178	10.9	21.1	28.6	19.1			8.12	48.1
x 36	10.6	15.9	0.295	3/16	6.99	0.430	0.832	1 1/8	¾			8.12	48.1	
W410 W16	x 46.1	5890	404	6.99	3.18	140	11.2	21.4	28.6	19.1	346.1	88.9	6.28	51.6
	x 31	9.13	15.9	0.275	1/8	5.53	0.440	0.842	1 1/8	¾	13 5/8	3 ½	6.28	51.6
W410 W16	x 38.8	4950	399	6.35	3.18	140	8.76	19.0	27.0	19.1	346.1	88.9	7.97	56.8
x 26	7.68	15.7	0.250	1/8	5.50	0.345	0.747	1 1/16	¾	13 5/8	3 ½	7.97	56.8	

PERFILES ESTRUCTURALES VIGAS DE ALA ANCHA

Peso nominal	Eje X-X				Eje Y-Y				rts	ho	Propiedades de torsión		Área de revestimiento
	I	S	r	Z	I	S	r	Z			J	Cw	
kg/m lb/ft	mm ⁴ /10 ⁶ in ⁴	mm ³ /10 ³ in ³	mm in	in ³ mm ³ /10 ³	mm ⁴ /10 ⁶ in ⁴	mm ³ /10 ³ in ³	mm in	mm ³ /10 ³ in ³	mm in	mm in	mm ⁴ /10 ³ in ⁴	mm ⁶ /10 ⁶ in ⁶	m ² /m ft ² /ft
106 71	487 1170	2080 127	191 7.50	2390 146	25.1 60.3	259 15.8	43.2 1.70	405 24.7	52.1 2.05	450 17.7	1450 3.49	1260 4700	1.69 5.55
97 65	445 1070	1920 117	190 7.49	2180 133	22.8 54.8	236 14.4	42.9 1.69	369 22.5	51.6 2.03	450 17.7	1140 2.73	1140 4240	1.68 5.52
89 60	410 984	1770 108	190 7.47	2020 123	20.9 50.1	218 13.3	42.7 1.68	338 20.6	51.3 2.02	444 17.5	903 2.17	1030 3850	1.67 5.48
82 55	370 890	1610 98.3	188 7.41	1840 112	18.7 44.9	195 11.9	42.4 1.67	303 18.5	50.8 2.00	444 17.5	691 1.66	921 3430	1.66 5.46
74 50	333 800	1460 88.9	187 7.38	1660 101	16.7 40.1	175 10.7	41.9 1.65	272 16.6	50.3 1.98	442 17.4	516 1.24	816 3040	1.66 5.44
68 46	296 712	1290 78.8	184 7.25	1490 90.7	9.37 22.5	122 7.43	32.8 1.29	192 11.7	40.1 1.58	444 17.5	508 1.22	462 1720	1.52 4.98
60 40	255 612	1120 68.4	183 7.21	1280 78.4	7.95 19.1	104 6.35	32.3 1.27	164 10.0	39.6 1.56	442 17.4	337 0.810	387 1440	1.50 4.94
52 35	212 510	944 57.6	179 7.04	1090 66.5	6.37 15.3	83.9 5.12	31.0 1.22	132 8.06	38.4 1.51	439 17.3	211 0.506	306 1140	1.49 4.90
149 100	620 1490	2870 175	180 7.10	3240 198	77.4 186	585 35.7	63.8 2.51	900 54.9	74.2 2.92	406 16.0	3220 773	3200 11900	1.89 6.20
132 89	541 1300	2540 155	179 7.05	2870 175	67.8 163	515 31.4	63.2 2.49	788 48.1	73.2 2.88	404 15.9	2270 5.45	2740 10200	1.88 6.18
114 77	462 1110	2200 134	178 7.00	2460 150	57.4 138	441 26.9	62.7 2.47	674 41.1	72.4 2.85	399 15.7	1490 3.57	2310 8590	1.86 6.11
100 67	397 954	1920 117	177 6.96	2130 130	49.5 119	380 23.2	62.5 2.46	582 35.5	71.6 2.82	396 15.6	995 2.39	1960 7300	1.84 6.05
85 57	316 758	1510 92.2	171 6.72	1720 105	17.9 43.1	198 12.1	40.6 1.60	310 18.9	48.8 1.92	399 15.7	924 2.22	714 2660	1.53 5.04
75 50	274 659	1330 81.0	170 6.68	1510 92.0	15.5 37.2	172 10.5	40.4 1.59	267 16.3	48.0 1.89	399 15.7	633 1.52	610 2270	1.53 5.01
67 45	244 586	1190 72.7	169 6.65	1350 82.3	13.7 32.8	153 9.34	39.9 1.57	238 14.5	47.5 1.87	394 15.5	462 1.11	534 1990	1.52 4.97
60 40	216 518	1060 64.7	168 6.63	1200 73.0	12.0 28.9	135 8.25	39.9 1.57	208 12.7	47.2 1.86	394 15.5	330 0.794	465 1730	1.51 4.95
53 36	186 448	926 56.5	165 6.51	1050 64.0	10.2 24.5	115 7.00	38.6 1.52	177 10.8	46.5 1.83	394 15.5	227 0.545	392 1460	1.50 4.93
46.1 31	156 375	773 47.2	163 6.41	885 54.0	5.16 12.4	73.6 4.49	29.7 1.17	115 7.03	36.1 1.42	394 15.5	192 0.461	198 739	1.36 4.45
38.8 26	125 301	629 38.4	159 6.26	724 44.2	3.99 9.59	57.2 3.49	28.4 1.12	89.8 5.48	35.1 1.38	391 15.4	109 0.262	152 565	1.34 4.41

VIGAS DE ALA ANCHA

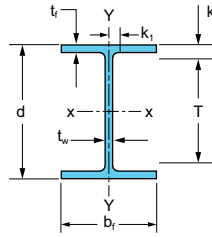

Tamaño del haz		Área A	Profundidad d	Alma		Ala		Distancia				Criterios de sección compacta		
				Espesor t _w	t _w /2	b _f	t _f	k		k ₁	T	Calibre viable	b _f /2t _f	h/t _w
								k _{des}	k _{det}					
		mm ² in ²	mm in	mm in	mm in	mm in	mm in	mm in	mm in	mm in	mm in	mm in	mm in	
W360 W14	x 1086	139000	569	78.0	39.7	455	125	140	157	69.9	254.0 10	76-191-76 3 - 7½ - 3	1.82	3.71
	x 730	215	22.4	3.07	19/16	179	4.91	5.51	6 3/16	2 ¾			1.82	3.71
	x 990	126000	549	71.9	36.5	450	115	130	148	66.7			1.95	4.03
	x 665	196	21.6	2.83	17/16	177	4.52	5.12	5 13/16	2 5/8			1.95	4.03
	x 900	115000	531	66.0	33.3	442	106	121	138	63.5			2.09	4.39
	x 605	178	20.9	2.60	15/16	174	4.16	4.76	5 7/16	2 ½			2.09	4.39
	x 818	105000	513	60.5	30.2	437	97.0	112	130	60.3			2.25	4.79
	x 550	162	20.2	2.38	13/16	172	3.82	4.42	5 1/8	2 3/8			2.25	4.79
	x 744	94800	498	55.6	28.6	432	88.9	104	122	58.7			2.43	5.21
	x 500	147	19.6	2.19	11/8	170	3.50	4.10	4 13/16	2 5/16			2.43	5.21
	x 677	86500	483	51.3	25.4	427	81.5	96.8	114	57.2			2.62	5.66
	x 455	134	19.0	2.02	1	16.8	3.21	3.81	4 ½	2 ¼			2.62	5.66
	x 634	80600	475	47.8	23.8	424	77.2	92.2	110	54.0			2.75	6.08
	x 426	125	18.7	1.88	15/16	16.7	3.04	3.63	4 5/16	2 1/8			2.75	6.08
	x 592	75500	465	45.0	22.2	422	72.4	87.4	105	54.0			2.92	6.44
	x 398	117	18.3	1.77	7/8	16.6	2.85	3.44	4 1/8	2 1/8			2.92	6.44
	x 551	70300	455	42.2	20.6	419	67.6	82.8	100	52.4			3.10	6.89
	x 370	109	17.9	1.66	13/16	16.5	2.66	3.26	3 15/16	2 1/16			3.10	6.89
	x 509	65200	445	39.1	20.6	417	62.7	78.0	95.3	50.8			3.31	7.41
	x 342	101	17.5	1.54	13/16	16.4	2.47	3.07	3 ¾	2			3.31	7.41
	x 463	59000	434	35.8	19.0	411	57.4	72.6	90.5	49.2			3.59	8.09
	x 311	91.4	17.1	1.41	¾	16.2	2.26	2.86	3 9/16	1 15/16			3.59	8.09
	x 421	53700	424	32.8	17.5	409	52.6	67.8	85.7	47.6			3.89	8.84
	x 283	83.3	16.7	1.29	11/16	16.1	2.07	2.67	3 3/8	1 7/8			3.89	8.84
	x 382	48800	417	30.0	15.9	406	48.0	63.2	81.0	46.0			4.23	9.71
	x 257	75.6	16.4	1.18	5/8	16.0	1.89	2.49	3 3/16	1 13/16			4.23	9.71
x 347	44200	406	27.2	14.3	404	43.7	58.9	76.2	44.5	4.62	10.7			
x 233	68.5	16.0	1.07	9/16	15.9	1.72	2.32	3	1 ¾	4.62	10.7			
x 314	40000	399	24.9	12.7	401	39.6	54.9	73.0	42.9	5.06	11.6			
x 211	62.0	15.7	0.980	½	15.8	1.56	2.16	2 7/8	1 11/16	5.06	11.6			
x 287	36600	394	22.6	11.1	399	36.6	51.8	69.9	42.9	5.45	12.8			
x 193	56.8	15.5	0.890	7/16	15.7	1.44	2.04	2 ¾	1 11/16	5.45	12.8			
x 262	33400	386	21.1	11.1	399	33.3	48.5	66.7	41.3	5.97	13.7			
x 176	51.8	15.2	0.830	7/16	15.7	1.31	1.91	2 5/8	1 5/8	5.97	13.7			
x 237	30100	381	18.9	9.52	396	30.2	45.5	63.5	39.7	6.54	15.3			
x 159	46.7	15.0	0.745	3/8	15.6	1.19	1.79	2 ½	1 9/16	6.54	15.3			
x 216	27500	376	17.3	9.52	394	27.7	42.9	60.3	39.7	7.11	16.8			
x 145	42.7	14.8	0.680	3/8	15.5	1.09	1.69	2 3/8	1 9/16	7.11	16.8			
W360 W14	x 196	25000	373	16.4	7.94	373	26.2	41.4	58.7	39.7	254.0 10	139.7 5 ½	7.15	17.7
	x 132	38.8	14.7	0.645	5/16	14.7	1.03	1.63	2 5/16	1 9/16			7.15	17.7
	x 179	22800	368	15.0	7.94	373	23.9	39.1	57.2	38.1			7.80	19.3
	x 120	35.3	14.5	0.590	5/16	14.7	0.940	1.54	2 ¼	1 ½			7.80	19.3
	x 162	20600	363	13.3	6.35	371	21.8	37.1	55.6	38.1			8.49	21.7
	x 109	32.0	14.3	0.525	¼	14.6	0.860	1.46	2 3/16	1 ½			8.49	21.7
	x 147	18800	361	12.3	6.35	371	19.8	35.1	52.4	36.5			9.34	23.5
x 99	29.1	14.2	0.485	¼	14.6	0.780	1.38	2 1/16	1 7/16	9.34	23.5			
W360 W14	x 134	17100	356	11.2	6.35	368	18.0	33.3	50.8	36.5	276.2 10 7/8	139.7 5 ½	10.2	25.9
	x 90	26.5	14.0	0.440	¼	14.5	0.710	1.31	2	1 7/16			10.2	25.9
	x 122	15500	363	13.0	6.35	257	21.7	36.8	42.9	27.0			5.92	22.4
	x 82	24.0	14.3	0.510	¼	10.1	0.855	1.45	1 11/16	1 1/16			5.92	22.4
	x 110	14100	361	11.4	6.35	257	19.9	35.1	41.3	27.0			6.41	25.4
x 74	21.8	14.2	0.450	¼	10.1	0.785	1.38	1 5/8	1 1/16	6.41	25.4			
W360 W14	x 101	12900	356	10.5	6.35	254	18.3	33.3	39.7	27.0	276.2 10 7/8	139.7 5 ½	6.97	27.5
	x 68	20.0	14.0	0.415	¼	10.0	0.720	1.31	1 9/16	1 1/16			6.97	27.5
	x 91	11500	353	9.53	4.76	254	16.4	31.5	38.1	25.4			7.75	30.4
x 61	17.9	13.9	0.375	3/16	10.0	0.645	1.24	1 ½	1	7.75	30.4			

PERFILES ESTRUCTURALES
VIGAS DE ALA ANCHA

Peso nominal	Eje X-X				Eje Y-Y				rts	ho	Propiedades de torsión		Área de revestimiento
	I	S	r	Z	I	S	r	Z			J	Cw	
kg/m lb/ft	mm ⁴ /10 ⁶ in ⁴	mm ³ /10 ³ in ³	mm in	in ³ mm ³ /10 ³	mm ⁴ /10 ⁶ in ⁴	mm ³ /10 ³ in ³	mm in	mm ³ /10 ³ in ³	mm in	mm in	mm ⁴ /10 ³ in ⁴	mm ⁶ /10 ⁶ in ⁶	m ² /m ft ² /ft
1086 730	5950 14300	21000 1280	208 8.17	27200 1660	1960 4720	8640 527	119 4.69	13400 816	144 5.68	444 17.5	604000 1450	97200 362000	2.80 9.19
990 665	5160 12400	18800 1150	203 7.98	24300 1480	1740 4170	7730 472	117 4.62	12000 730	141 5.57	434 17.1	466000 1120	81900 305000	2.75 9.03
900 605	4500 10800	17000 1040	198 7.80	21600 1320	1530 3680	6930 423	116 4.55	10700 652	138 5.44	424 16.7	362000 869	69300 258000	2.70 8.85
818 550	3930 9430	15300 931	194 7.63	19300 1180	1350 3250	6190 378	114 4.49	9550 583	136 5.35	417 16.4	278000 669	58800 219000	2.65 8.70
744 500	3420 8210	13700 838	190 7.48	17200 1050	1200 2880	5560 339	113 4.43	8550 522	134 5.26	409 16.1	214000 514	50200 187000	2.61 8.57
677 455	2990 7190	12400 756	186 7.33	15300 936	1070 2560	4980 304	111 4.38	7670 468	131 5.17	401 15.8	164000 395	43000 160000	2.57 8.43
634 426	2750 6600	11600 706	184 7.26	14200 869	982 2360	4640 283	110 4.34	7110 434	130 5.11	399 15.7	138000 331	38700 144000	2.55 8.37
592 398	2500 6000	10700 656	182 7.16	13100 801	903 2170	4290 262	109 4.31	6590 402	128 5.05	394 15.5	114000 273	34600 129000	2.53 8.29
551 370	2260 5440	9950 607	180 7.07	12100 736	828 1990	3950 241	108 4.27	6060 370	127 5.00	386 15.2	92400 222	31200 116000	2.50 8.21
509 342	2040 4900	9140 558	177 6.98	11000 672	753 1810	3620 221	108 4.24	5540 338	126 4.95	381 15.0	74100 178	27700 103000	2.48 8.13
463 311	1800 4330	8290 506	175 6.88	9880 603	670 1610	3260 199	107 4.20	4980 304	124 4.87	376 14.8	56600 136	23900 89100	2.44 8.02
421 283	1600 3840	7520 459	172 6.79	8880 542	599 1440	2930 179	106 4.17	4490 274	122 4.80	371 14.6	43300 104	20900 77700	2.42 7.94
382 257	1420 3400	6800 415	170 6.71	7980 487	537 1290	2640 161	105 4.13	4030 246	121 4.75	368 14.5	32900 791	18200 67800	2.40 7.87
347 233	1250 3010	6150 375	168 6.63	7140 436	479 1150	2380 145	104 4.10	3620 221	119 4.69	363 14.3	24800 59.5	15800 59000	2.37 7.79
314 211	1110 2660	5540 338	166 6.55	6390 390	429 1030	2130 130	103 4.07	3240 198	118 4.64	358 14.1	18600 44.6	13800 51500	2.35 7.72
287 193	999 2400	5080 310	165 6.50	5820 355	388 931	1950 119	103 4.05	2950 180	117 4.59	358 14.1	14500 34.8	12300 45900	2.34 7.67
262 176	891 2140	4600 281	163 6.43	5240 320	349 838	1750 107	102 4.02	2670 163	116 4.55	353 13.9	11000 26.5	10900 40500	2.33 7.63
237 159	791 1900	4160 254	162 6.38	4700 287	311 748	1580 96.2	102 4.00	2390 146	115 4.51	351 13.8	8200 19.7	9560 35600	2.31 7.58
216 145	712 1710	3800 232	161 6.33	4260 260	282 677	1430 87.3	101 3.98	2180 133	114 4.47	348 13.7	6330 15.2	8510 31700	2.29 7.52
196 132	637 1530	3420 209	160 6.28	3830 234	228 548	1220 74.5	95.5 3.76	1850 113	107 4.23	348 13.7	5120 12.3	6850 25500	2.21 7.24
179 120	574 1380	3110 190	158 6.24	3470 212	206 495	1110 67.5	95.0 3.74	1670 102	107 4.20	345 13.6	3900 9.37	6100 22700	2.20 7.22
162 109	516 1240	2830 173	158 6.22	3150 192	186 447	1000 61.2	94.7 3.73	1520 92.7	106 4.17	340 13.4	2960 712	5420 20200	2.18 7.16
147 99	462 1110	2570 157	157 6.17	2830 173	167 402	905 55.2	94.2 3.71	1370 83.6	105 4.14	340 13.4	2240 5.37	4830 18000	2.18 7.15
134 90	416 999	2340 143	156 6.14	2570 157	151 362	818 49.9	94.0 3.70	1240 75.6	104 4.10	338 13.3	1690 4.06	4300 16000	2.16 7.09
122 82	367 881	2020 123	154 6.05	2280 139	61.6 148	480 29.3	63.0 2.48	734 44.8	72.4 2.85	340 13.4	2110 5.07	1800 6710	1.73 5.67
110 74	331 795	1840 112	153 6.04	2060 126	55.8 134	436 26.6	63.0 2.48	664 40.5	71.9 2.83	340 13.4	1610 3.87	1610 5990	1.72 5.66
68 101	722 301	103 1690	6.01 153	115 1880	121 50.4	24.2 397	2.46 62.5	36.9 605	2.80 7.11	13.3 338	3.01 1250	5380 1440	5.60 1.71
61 91	640 266	92.1 1510	5.98 152	102 1670	107 44.5	21.5 352	2.45 62.2	32.8 537	2.78 70.6	13.3 338	2.19 912	4710 1260	5.59 1.70

VIGAS DE ALA ANCHA

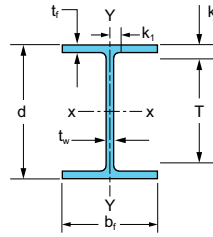

Tamaño del haz	Área A	Profundidad d	Alma		Ala		Distancia				Criterios de sección compacta			
			Espesor t _w	t _w /2	b _f	t _f	k		k ₁	T	Calibre viable	b _f /2t _f	h/t _w	
							k _{des}	k _{det}						
mm ² in ²	mm in	mm in	mm in	mm in	mm in	mm in	mm in	mm in	mm in	mm in	mm in	mm in	mm in	
W360 W14	x 79	10100	353	9.40	4.76	205	16.8	31.8	38.1	25.4	276.2	139.7	6.11	30.9
	x 53	15.6	13.9	0.370	3/16	8.06	0.660	1.25	1 1/2	1	10 7/8	5 1/2	6.11	30.9
	x 72	9100	351	8.64	4.76	204	15.1	30.2	36.5	25.4			6.75	33.6
	x 48	14.1	13.8	0.340	3/16	8.03	0.595	1.19	1 7/16	1			6.75	33.6
W360 W14	x 64	8130	348	7.75	4.76	203	13.5	28.4	34.9	25.4			7.54	37.4
	x 43	12.6	13.7	0.305	3/16	8.00	0.530	1.12	1 3/8	1			7.54	37.4
	x 57.8	7230	358	7.87	4.76	172	13.1	23.2	31.8	20.6	295.3	88.9	6.57	39.6
	x 38	11.2	14.1	0.310	3/16	6.77	0.515	0.915	1 1/4	13/16	11 5/8	3 1/2	6.57	39.6
W360 W14	x 51	6450	356	7.24	4.76	171	11.6	21.7	30.2	19.1			7.41	43.1
	x 34	10.0	14.0	0.285	3/16	6.75	0.455	0.855	1 3/16	3/4			7.41	43.1
	x 44	5710	351	6.86	3.18	171	9.78	19.9	28.6	19.1			8.74	45.4
	x 30	8.85	13.8	0.270	1/8	6.73	0.385	0.785	1 1/8	3/4			8.74	45.4
W360 W14	x 39	4960	353	6.48	3.18	128	10.7	20.8	28.6	19.1	295.3	69.9	5.98	48.1
	x 26	7.69	13.9	0.255	1/8	5.03	0.420	0.820	1 1/8	3/4	11 5/8	2 3/4	5.98	48.1
	x 32.9	4190	348	5.84	3.18	127	8.51	18.7	27.0	19.1	295.3	69.9	7.46	53.3
W310 W12	x 22	6.49	13.7	0.230	1/8	5.00	0.335	0.735	1 1/16	3/4	11 5/8	2 3/4	7.46	53.3
	x 500	63800	427	45.2	22.2	340	75.2	90.2	98.4	42.9	231.8	139.7	2.26	5.47
	x 336	98.9	16.8	1.78	7/8	13.4	2.96	3.55	3 7/8	1 11/16	9 1/8	5 1/2	2.26	5.47
	x 454	57700	414	41.4	20.6	335	68.8	83.8	92.1	41.3			2.45	5.98
	x 305	89.5	16.3	1.63	13/16	13.2	2.71	3.30	3 5/8	1 5/8			2.45	5.98
	x 415	52800	404	38.9	19.0	333	62.7	78.0	85.7	41.3			2.66	6.35
	x 279	81.9	15.9	1.53	3/4	13.1	2.47	3.07	3 3/8	1 5/8			2.66	6.35
	x 375	47800	391	35.6	17.5	330	57.2	72.4	79.4	38.1			2.89	6.96
	x 252	74.1	15.4	1.40	1 1/16	13.0	2.25	2.85	3 1/8	1 1/2			2.89	6.96
	x 342	43700	384	32.8	17.5	328	52.6	67.8	74.6	38.1			3.11	7.56
	x 230	67.7	15.1	1.29	1 1/16	12.9	2.07	2.67	2 15/16	1 1/2			3.11	7.56
	x 313	39900	373	30.0	15.9	325	48.3	63.5	71.4	36.5			3.37	8.23
	x 210	61.8	14.7	1.18	5/8	12.8	1.90	2.50	2 13/16	1 7/16			3.37	8.23
	x 283	36100	366	26.9	14.3	323	44.2	59.2	66.7	34.9			3.65	9.16
	x 190	56.0	14.4	1.06	9/16	12.7	1.74	2.33	2 5/8	1 3/8			3.65	9.16
	x 253	32300	356	24.4	12.7	320	39.6	54.9	61.9	33.3			4.03	10.1
	x 170	50.0	14.0	0.960	1/2	12.6	1.56	2.16	2 7/16	1 5/16			4.03	10.1
	x 226	28800	348	22.1	11.1	318	35.6	50.8	58.7	31.8			4.46	11.2
	x 152	44.7	13.7	0.870	7/16	12.5	1.40	2.00	2 5/16	1 1/4			4.46	11.2
	x 202	25700	340	20.1	11.1	315	31.8	47.0	54.0	31.8			4.96	12.3
x 136	39.9	13.4	0.790	7/16	12.4	1.25	1.85	2 1/8	1 1/4			4.96	12.3	
x 179	22700	333	18.0	9.52	312	28.2	43.2	50.8	30.2			5.57	13.7	
x 120	35.2	13.1	0.710	3/8	12.3	1.11	1.70	2	1 3/16			5.57	13.7	
x 158	20100	328	15.5	7.94	310	25.1	40.4	47.6	28.6			6.17	15.9	
x 106	31.2	12.9	0.610	5/16	12.2	0.990	1.59	1 7/8	1 1/8			6.17	15.9	
x 143	18200	323	14.0	7.94	310	22.9	38.1	46.0	28.6			6.76	17.7	
x 96	28.2	12.7	0.550	5/16	12.2	0.900	1.50	1 13/16	1 1/8			6.76	17.7	
x 129	16500	318	13.1	6.35	307	20.6	35.8	42.9	27.0			7.48	18.9	
x 87	25.6	12.5	0.515	1/4	12.1	0.810	1.41	1 11/16	1 1/16			7.48	18.9	
x 117	15000	315	11.9	6.35	307	18.7	33.8	41.3	27.0			8.22	20.7	
x 79	23.2	12.4	0.470	1/4	12.1	0.735	1.33	1 5/8	1 1/16			8.22	20.7	
x 107	13600	312	10.9	6.35	305	17.0	32.3	39.7	27.0			8.99	22.6	
x 72	21.1	12.3	0.430	1/4	12.0	0.670	1.27	1 9/16	1 1/16			8.99	22.6	
x 97	12300	307	9.91	4.76	305	15.4	30.5	38.1	25.4			9.92	24.9	
x 65	19.1	12.1	0.390	3/16	12.0	0.605	1.20	1 1/2	1			9.92	24.9	
W310 W12	x 86	11000	310	9.14	4.76	254	16.3	31.5	38.1	23.8	235.0	139.7	7.82	27.0
	x 58	17.0	12.2	0.360	3/16	10.0	0.640	1.24	1 1/2	15/16	9 3/4	5 1/2	7.82	27.0
	x 79	10100	307	8.76	4.76	254	14.6	30.0	34.9	23.8	235.0	139.7	8.69	28.1
x 53	15.6	12.1	0.345	3/16	10.0	0.575	1.18	1 3/8	15/16	9 3/4	5 1/2	8.69	28.1	

PERFILES ESTRUCTURALES
VIGAS DE ALA ANCHA

Peso nominal	Eje X-X				Eje Y-Y				rts	ho	Propiedades de torsión		Área de revestimiento
	I	S	r	Z	I	S	r	Z			J	Cw	
kg/m lb/ft	mm ⁴ /10 ⁶ in ⁴	mm ³ /10 ³ in ³	mm in	in ³ mm ³ /10 ³	mm ⁴ /10 ⁶ in ⁴	mm ³ /10 ³ in ³	mm in	mm ³ /10 ³ in ³	mm in	mm in	mm ⁴ /10 ³ in ⁴	mm ⁶ /10 ⁶ in ⁶	m ² /m ft ² /ft
79 53	225 541	1270 778	150 5.89	1430 871	24.0 577	234 14.3	48.8 1.92	361 22.0	56.4 2.22	335 13.2	807 1.94	682 2540	1.51 4.94
72 48	201 484	1150 70.2	149 5.85	1280 78.4	21.4 51.4	210 12.8	48.5 1.91	321 19.6	55.9 2.20	335 13.2	604 1.45	602 2240	1.50 4.92
64 43	178 428	1030 62.6	148 5.82	1140 69.6	18.8 45.2	185 11.3	48.0 1.89	283 17.3	55.4 2.18	335 13.2	437 1.05	524 1950	1.49 4.90
57.8 38	160 385	895 54.6	149 5.87	1010 61.5	11.1 26.7	129 7.88	39.4 1.55	198 12.1	46.2 1.82	345 13.6	332 0.798	330 1230	1.39 4.56
51 34	142 340	796 48.6	148 5.83	895 54.6	9.70 23.3	113 6.91	38.9 1.53	174 10.6	45.7 1.80	343 13.5	237 0.569	287 1070	1.38 4.54
44 30	121 291	688 42.0	146 5.73	775 47.3	8.16 19.6	95.4 5.82	37.8 1.49	147 8.99	45.0 1.77	340 13.4	158 0.380	238 887	1.37 4.50
39 26	102 245	578 35.3	144 5.65	659 40.2	3.71 8.91	58.2 3.55	27.4 1.08	90.8 5.54	33.0 1.30	343 13.5	149 0.358	109 405	1.20 3.95
32.9 22	82.8 199	475 29.0	141 5.54	544 33.2	2.91 7.00	45.9 2.80	26.4 1.04	71.9 4.39	32.3 1.27	340 13.4	86.6 0.208	84.3 314	1.19 3.91
500 336	1690 4060	7910 483	163 6.41	9880 603	495 1190	2900 177	88.1 3.47	4490 274	105 4.13	351 13.8	101000 243	15300 57000	2.12 6.97
454 305	1480 3550	7130 435	160 6.29	8800 537	437 1050	2610 159	86.9 3.42	4000 244	103 4.05	345 13.6	77000 185	13100 48600	2.09 6.85
415 279	1290 3110	6440 393	156 6.16	7880 481	390 937	2340 143	85.9 3.38	3610 220	102 4.00	340 13.4	59500 143	11300 42000	2.06 6.76
375 252	1130 2720	5780 353	154 6.06	7010 428	345 828	2080 127	84.8 3.34	3210 196	99.8 3.93	335 13.2	45000 108	9610 35800	2.03 6.67
342 230	1010 2420	5260 321	152 5.97	6330 386	309 742	1880 115	84.1 3.31	2900 177	98.3 3.87	330 13.0	34900 83.8	8380 31200	2.01 6.60
313 210	891 2140	4790 292	150 5.89	5700 348	276 664	1700 104	83.3 3.28	2610 159	96.8 3.81	325 12.8	26900 64.7	7300 27200	1.99 6.52
283 190	787 1890	4310 263	148 5.82	5100 311	245 589	1520 93.0	82.6 3.25	2340 143	95.8 3.77	323 12.7	20300 48.8	6340 23600	1.97 6.46
253 170	687 1650	3850 235	146 5.74	4510 275	215 517	1350 82.3	81.8 3.22	2060 126	94.0 3.70	315 12.4	14800 35.6	5400 20100	1.94 6.37
226 152	595 1430	3420 209	144 5.66	3980 243	189 454	1190 72.8	81.0 3.19	1820 111	93.0 3.66	312 12.3	10700 25.8	4620 17200	1.92 6.31
202 136	516 1240	3050 186	142 5.58	3510 214	166 398	1050 64.2	80.3 3.16	1610 98.0	91.7 3.61	310 12.2	7700 18.5	3950 14700	1.90 6.24
179 120	445 1070	2670 163	140 5.51	3050 186	144 345	918 56.0	79.5 3.13	1400 85.4	90.4 3.56	305 12.0	5370 12.9	3330 12400	1.88 6.17
158 106	388 933	2380 145	139 5.47	2690 164	125 301	808 49.3	79.0 3.11	1230 75.1	89.4 3.52	302 11.9	3800 913	2870 10700	1.86 6.12
143 96	347 833	2150 131	138 5.44	2410 147	112 270	728 44.4	78.5 3.09	1110 67.5	88.6 3.49	300 11.8	2850 6.85	2530 9410	1.86 6.09
129 87	308 740	1930 118	137 5.38	2160 132	100 241	651 39.7	78.0 3.07	990 60.4	87.9 3.46	297 11.7	2120 510	2220 8270	1.84 6.03
117 79	276 662	1750 107	136 5.34	1950 119	89.9 216	587 35.8	77.5 3.05	890 54.3	87.1 3.43	297 11.7	1600 3.84	1970 7330	1.84 6.02
107 72	248 597	1600 97.4	135 5.31	1770 108	81.2 195	531 32.4	77.2 3.04	806 49.2	86.6 3.41	295 11.6	1220 2.93	1760 6540	1.82 5.98
97 65	222 533	1440 87.9	134 5.28	1590 96.8	72.4 174	477 29.1	76.7 3.02	723 44.1	85.9 3.38	292 11.5	907 2.18	1550 5780	1.81 5.95
86 58	198 475	1280 78.0	134 5.28	1420 86.4	44.5 107	351 21.4	63.8 2.51	533 32.5	71.4 2.81	295 11.6	874 2.10	959 3570	1.62 5.31
79 53	177 425	1160 70.6	133 5.23	1280 77.9	39.9 95.8	315 19.2	63.0 2.48	477 29.1	70.9 2.79	292 11.5	658 1.58	849 3160	1.61 5.29

VIGAS DE ALA ANCHA

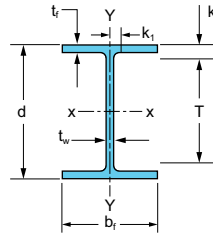

Tamaño del haz	Área A	Profundidad d	Alma		Ala		Distancia				Criterios de sección compacta			
			Espesor t _w	t _w /2	b _f	t _f	k		k ₁	T	Calibre viable	b _f /2t _f	h/t _w	
							k _{des}	k _{det}						
mm ² in ²	mm in	mm in	mm in	mm in	mm in	mm in	mm in	mm in	mm in	mm in				
W310 W12	x 74	9420	310	9.40	4.76	205	16.3	29.0	38.1	23.8	235.0	139.7	6.31	26.8
	x 50	14.6	12.2	0.370	3/16	8.08	0.640	1.14	1 1/2	15/16	9 1/4	5 1/2	6.31	26.8
	x 67	8450	307	8.51	4.76	204	14.6	27.4	34.9	23.8			7.00	29.6
	x 45	13.1	12.1	0.335	3/16	8.05	0.575	1.08	1 3/8	15/16			7.00	29.6
W310 W12	x 60	7550	302	7.49	4.76	203	13.1	25.9	34.9	22.2			7.77	33.6
	x 40	11.7	11.9	0.295	3/16	8.01	0.515	1.02	1 3/8	7/8			7.77	33.6
	x 52	6650	318	7.62	4.76	167	13.2	20.8	30.2	19.1	257.2	88.9	6.31	36.2
	x 35	10.3	12.5	0.300	3/16	6.56	0.520	0.820	1 3/16	3/4	10 1/8	3 1/2	6.31	36.2
W310 W12	x 44.5	5670	312	6.60	3.18	166	11.2	18.8	28.6	19.1			7.41	41.8
	x 30	8.79	12.3	0.260	1/8	6.52	0.440	0.740	1 1/8	3/4			7.41	41.8
	x 38.7	4940	310	5.84	3.18	165	9.65	17.3	27.0	19.1			8.54	47.2
	x 26	7.65	12.2	0.230	1/8	6.49	0.380	0.680	1 1/16	3/4			8.54	47.2
W310 W12	x 32.7	4180	312	6.60	3.18	102	10.8	18.4	23.8	15.9	263.5	57.2	4.74	41.8
	x 22	6.48	12.3	0.260	1/8	4.03	0.425	0.725	15/16	5/8	10 3/8	2 1/4	4.74	41.8
	x 28.3	3590	310	5.97	3.18	102	8.89	16.5	22.2	14.3			5.72	46.2
	x 19	5.57	12.2	0.235	1/8	4.01	0.350	0.650	7/8	9/16			5.72	46.2
W310 W12	x 23.8	3040	305	5.59	3.18	101	6.73	14.4	20.6	14.3			7.53	49.4
	x 16	4.71	12.0	0.220	1/8	3.99	0.265	0.565	13/16	9/16			7.53	49.4
	x 21	2680	302	5.08	3.18	101	5.72	13.3	19.1	14.3			8.82	54.3
	x 14	4.16	11.9	0.200	1/8	3.97	0.225	0.525	3/4	9/16			8.82	54.3
W250 W10	x 167	21200	290	19.2	9.52	264	31.8	44.5	49.2	25.4	190.5	139.7	4.17	10.4
	x 112	32.9	11.4	0.755	3/8	10.4	1.25	1.75	115/16	1	7 1/2	5 1/2	4.17	10.4
	x 149	18900	282	17.3	9.52	262	28.4	41.1	46.0	25.4			4.62	11.6
	x 100	29.3	11.1	0.680	3/8	10.3	1.12	1.62	113/16	1			4.62	11.6
W250 W10	x 131	16800	274	15.4	7.94	262	25.1	37.8	42.9	23.8			5.18	13.0
	x 88	26.0	10.8	0.605	5/16	10.3	0.990	1.49	111/16	15/16			5.18	13.0
	x 115	14600	269	13.5	6.35	259	22.1	34.8	39.7	22.2			5.86	14.8
	x 77	22.7	10.6	0.530	3/4	10.2	0.870	1.37	19/16	7/8			5.86	14.8
W250 W10	x 101	12800	264	11.9	6.35	257	19.6	32.3	36.5	22.2			6.58	16.7
	x 68	19.9	10.4	0.470	3/4	10.1	0.770	1.27	17/16	7/8			6.58	16.7
	x 89	11400	259	10.7	6.35	257	17.3	30.0	34.9	20.6			7.41	18.7
	x 60	17.7	10.2	0.420	3/4	10.1	0.680	1.18	1 3/8	13/16			7.41	18.7
W250 W10	x 80	10200	257	9.40	4.76	254	15.6	28.4	33.3	20.6			8.15	21.2
	x 54	15.8	10.1	0.370	3/16	10.0	0.615	1.12	1 5/16	13/16			8.15	21.2
	x 73	9290	254	8.64	4.76	254	14.2	26.9	31.8	20.6			8.93	23.1
	x 49	14.4	10.0	0.340	3/16	10.0	0.560	1.06	1 1/4	13/16			8.93	23.1
W250 W10	x 67	8580	257	8.89	4.76	204	15.7	28.4	33.3	20.6	190.5	139.7	6.47	22.5
	x 45	13.3	10.1	0.350	3/16	8.02	0.620	1.12	1 5/16	13/16	7 1/2	5 1/2	6.47	22.5
	x 58	7420	252	8.00	4.76	203	13.5	26.2	30.2	20.6			7.53	25.0
	x 39	11.5	9.92	0.315	3/16	7.99	0.530	1.03	1 3/16	13/16			7.53	25.0
W250 W10	x 49.1	6260	247	7.37	4.76	202	11.0	23.7	28.6	19.1			9.15	27.1
	x 33	9.71	9.73	0.290	3/16	7.96	0.435	0.935	1 1/8	3/4			9.15	27.1
	x 44.8	5700	267	7.62	4.76	148	13.0	20.6	28.6	17.5	209.6	69.9	5.70	29.5
	x 30	8.84	10.5	0.300	3/16	5.81	0.510	0.810	1 1/8	11/16	8 1/4	2 3/4	5.70	29.5
W250 W10	x 38.5	4910	262	6.60	3.18	147	11.2	18.8	27.0	17.5			6.56	34.0
	x 26	7.61	10.3	0.260	1/8	5.77	0.440	0.740	1 1/16	11/16			6.56	34.0
	x 32.7	4190	259	6.10	3.18	146	9.14	16.8	23.8	15.9			7.99	36.9
	x 22	6.49	10.2	0.240	1/8	5.75	0.360	0.660	15/16	5/8			7.99	36.9
W250 W10	x 28.4	3630	259	6.35	3.18	102	10.0	17.7	23.8	15.9	212.7	57.2	5.09	35.4
	x 19	5.62	10.2	0.250	1/8	4.02	0.395	0.695	15/16	5/8	8 3/8	2 1/4	5.09	35.4
	x 25.3	3220	257	6.10	3.18	102	8.38	16.0	22.2	14.3			6.08	36.9
	x 17	4.99	10.1	0.240	1/8	4.01	0.330	0.330	7/8	9/16			6.08	36.9
W250 W10	x 22.3	2850	254	5.84	3.18	102	6.86	14.5	20.6	14.3			7.41	38.5
	x 15	4.41	9.99	0.230	1/8	4.00	0.270	0.570	13/16	9/16			7.41	38.5
	x 17.9	2280	251	4.83	3.18	101	5.33	13.0	19.1	14.3			9.43	46.6
	x 12	3.54	9.87	0.190	1/8	3.96	0.210	0.510	3/4	9/16			9.43	46.6

PERFILES ESTRUCTURALES
VIGAS DE ALA ANCHA

Peso nominal	Eje X-X				Eje Y-Y				rts	ho	Propiedades de torsión		Área de revestimiento
	I	S	r	Z	I	S	r	Z			J	Cw	
kg/m lb/ft	mm ⁴ /10 ⁶ in ⁴	mm ³ /10 ³ in ³	mm in	in ³ mm ³ /10 ³	mm ⁴ /10 ⁶ in ⁴	mm ³ /10 ³ in ³	mm in	mm ³ /10 ³ in ³	mm in	mm in	mm ⁴ /10 ³ in ⁴	mm ⁶ /10 ⁶ in ⁶	m ² /m ft ² /ft
74	163	1050	132	1180	23.4	228	49.8	349	57.2	295	712	505	1.42
50	391	64.2	5.18	71.9	56.3	13.9	1.96	21.3	2.25	11.6	1.71	1880	4.67
67	145	946	131	1050	20.8	203	49.5	311	56.6	292	524	443	1.42
45	348	57.7	5.15	64.2	50.0	12.4	1.95	19.0	2.23	11.5	1.26	1650	4.64
60	128	844	130	934	18.4	180	49.3	275	56.1	290	377	387	1.40
40	307	51.5	5.13	57.0	44.1	11.0	1.94	16.8	2.21	11.4	0.906	1440	4.60
52	119	747	133	839	10.2	122	39.1	188	45.5	305	308	236	1.29
35	285	45.6	5.25	51.2	24.5	7.47	1.54	11.5	1.79	12.0	0.741	879	4.22
44.5	99.1	633	132	706	8.45	102	38.6	157	45.0	302	190	193	1.27
30	238	38.6	5.21	43.1	20.3	6.24	1.52	9.56	1.77	11.9	0.457	720	4.18
38.7	84.9	547	131	610	7.20	87.5	38.4	134	44.4	300	125	163	1.27
26	204	33.4	5.17	37.2	17.3	5.34	1.51	8.17	1.75	11.8	0.300	607	4.16
32.7	64.9	416	125	480	1.94	379	21.5	60.0	26.4	302	122	44.0	1.02
22	156	25.4	4.91	29.3	4.66	2.31	0.848	3.66	1.04	11.9	0.293	164	3.35
28.3	54.1	349	122	405	1.57	30.8	20.9	48.8	25.9	302	74.9	35.2	1.02
19	130	21.3	4.82	24.7	3.76	1.88	0.822	2.98	1.02	11.9	0.180	131	3.33
23.8	42.9	280	119	329	1.17	23.1	19.6	37.0	25.0	297	42.9	26.0	1.00
16	103	17.1	4.67	20.1	2.82	1.41	0.773	2.26	0.983	11.7	0.103	96.9	3.29
21	36.9	244	117	285	0.982	19.5	19.1	31.1	24.4	297	29.3	21.6	1.00
14	88.6	14.9	4.62	17.4	2.36	1.19	0.753	1.90	0.961	11.7	0.070	80.4	3.27
167	298	2060	118	2410	98.2	742	68.1	1130	78.2	259	6290	1620	1.60
112	716	126	4.66	147	236	45.3	2.68	69.2	3.08	10.2	15.1	6020	5.24
149	259	1840	117	2130	86.2	655	67.3	1000	77.2	254	4540	1380	1.58
100	623	112	4.60	130	207	40.0	2.65	61.0	3.04	10.0	10.9	5150	5.17
131	222	1610	115	1850	74.5	570	66.8	870	75.9	249	3130	1160	1.56
88	534	98.5	4.54	113	179	34.8	2.63	53.1	2.99	9.81	75.3	4330	5.13
115	189	1410	114	1600	64.1	493	66.0	752	74.9	247	2130	975	1.55
77	455	85.9	4.49	97.6	154	30.1	2.60	45.9	2.95	9.73	5.11	3630	5.08
101	164	1240	113	1400	55.8	433	65.8	657	74.2	245	1480	832	1.53
68	394	75.7	4.44	85.3	134	26.4	2.59	40.1	2.92	9.63	3.56	3100	5.02
89	142	1090	112	1220	48.3	377	65.3	574	73.2	242	1030	709	1.52
60	341	66.7	4.39	74.6	116	23.0	2.57	35.0	2.88	9.52	2.48	2640	5.00
80	126	983	111	1090	42.9	338	65.0	513	72.4	241	758	623	1.51
54	303	60.0	4.37	66.6	103	20.6	2.56	31.3	2.85	9.49	1.82	2320	4.96
73	113	895	110	990	38.9	306	64.5	464	72.1	240	579	556	1.51
49	272	54.6	4.35	60.4	93.4	18.7	2.54	28.3	2.84	9.44	1.39	2070	4.94
67	103	805	110	900	22.2	218	51.1	333	57.7	241	629	322	1.31
45	248	49.1	4.32	54.9	53.4	13.3	2.01	20.3	2.27	9.48	1.51	1200	4.30
58	87.0	690	108	767	18.7	185	50.3	282	56.9	239	406	266	1.30
39	209	42.1	4.27	46.8	45.0	11.3	1.98	17.2	2.24	9.39	0.976	992	4.26
49.1	71.2	574	106	636	15.2	151	49.3	229	55.9	236	243	212	1.29
33	171	35.0	4.19	38.8	36.6	9.20	1.94	14.0	2.20	9.30	0.583	791	4.23
44.8	70.8	531	111	600	6.95	94.2	34.8	145	40.6	254	259	111	1.11
30	170	32.4	4.38	36.6	16.7	5.75	1.37	8.84	1.60	9.99	0.622	414	3.64
38.5	59.9	457	110	513	5.87	80.1	34.5	123	40.1	250	167	92.6	1.10
26	144	279	4.35	31.3	14.1	4.89	1.36	7.50	1.58	9.86	0.402	345	3.60
32.7	49.1	380	108	426	4.75	65.1	33.8	100	39.4	250	99.5	73.8	1.09
22	118	23.2	4.27	26.0	11.4	3.97	1.33	6.10	1.55	9.84	0.239	275	3.58
28.4	40.1	308	105	354	1.79	35.1	22.2	54.9	26.9	249	97.0	279	0.91
19	96.3	18.8	4.14	21.6	4.29	2.14	0.874	3.35	1.06	9.81	0.233	104	3.00
25.3	34.1	265	103	306	1.48	29.2	21.5	45.9	26.4	248	64.9	22.9	0.91
17	81.9	16.2	4.05	18.7	3.56	1.78	0.845	2.80	1.04	9.77	0.156	85.1	2.98
22.3	28.7	226	100	262	1.20	23.8	20.6	37.7	25.7	247	43.3	18.3	0.90
15	68.9	13.8	3.95	16.0	2.89	1.45	0.810	2.30	1.01	9.72	0.104	68.3	2.96
17.9	22.4	179	99.1	206	0.907	18.0	19.9	28.5	25.0	245	22.8	13.7	0.89
12	53.8	10.9	3.90	12.6	2.18	1.10	0.785	1.74	0.983	9.66	0.055	50.9	2.93

VIGAS DE ALA ANCHA

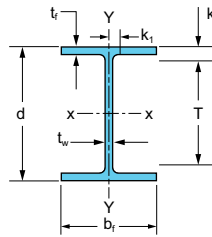

Tamaño del haz		Área A	Profundidad d	Alma		Ala		Distancia				Criterios de sección compacta		
				Espesor t _w	t _w /2	b _f	t _f	k		k ₁	T	Calibre viable	b _f /2t _f	h/t _w
								k _{des}	k _{det}					
		mm ² in ²	mm in	mm in	mm in	mm in	mm in	mm in	mm in	mm in	mm in	mm in	mm in	
W200 W8	x 100	12700	229	14.5	7.94	210	23.7	33.8	41.3	23.8	146.1	139.7	4.43	11.1
	x 67	19.7	9.00	0.570	5/16	8.28	0.935	1.33	1 5/8	15/16	5 3/8	5 1/2	4.43	11.1
	x 86	11000	222	13.0	6.35	209	20.6	30.5	38.1	22.2			5.07	12.4
	x 58	171	8.75	0.510	1/4	8.22	0.810	1.20	1 1/2	7/8			5.07	12.4
	x 71	9100	216	10.2	4.76	206	17.4	27.4	34.9	20.6			5.92	15.9
	x 48	141	8.50	0.400	3/16	8.11	0.685	1.08	1 3/8	13/16			5.92	15.9
W200 W8	x 59	7550	210	9.14	4.76	205	14.2	24.2	31.8	20.6			7.21	17.6
	x 40	11.7	8.25	0.360	3/16	8.07	0.560	0.954	1 1/4	13/16			7.21	17.6
	x 52	6650	206	7.87	4.76	204	12.6	22.6	30.2	20.6			8.10	20.5
	x 35	10.3	8.12	0.310	3/16	8.02	0.495	0.889	1 3/16	13/16			8.10	20.5
	x 46.1	5890	203	7.24	4.76	203	11.0	21.1	28.6	19.1			9.19	22.3
	x 31	9.13	8.00	0.285	3/16	8.00	0.435	0.829	1 1/8	13/16			9.19	22.3
W200 W8	x 41.7	5320	205	7.24	4.76	166	11.8	21.8	23.8	15.9	155.6	101.6	7.03	22.3
	x 28	8.25	8.06	0.285	3/16	6.54	0.465	0.859	15/16	5/8	6 1/8	4	7.03	22.3
W200 W8	x 35.9	4570	201	6.22	3.18	165	10.2	20.2	22.2	14.3	155.6	101.6	8.12	25.9
	x 24	7.08	7.93	0.245	1/8	6.50	0.400	0.794	7/8	9/16	6 1/8	4	8.12	25.9
W200 W8	x 31.3	3970	210	6.35	3.18	134	10.2	17.8	22.2	14.3	165.1	69.9	6.59	27.5
	x 21	6.16	8.28	0.250	1/8	5.27	0.400	0.700	7/8	9/16	6 1/2	2 3/4	6.59	27.5
W200 W8	x 26.6	3390	207	5.84	3.18	133	8.38	16.0	20.6	14.3	165.1	69.9	7.95	29.9
	x 18	5.26	8.14	0.230	1/8	5.25	0.330	0.630	13/16	9/16	6 1/2	2 3/4	7.95	29.9
W200 W8	x 22.5	2860	206	6.22	3.18	102	8.00	15.6	20.6	14.3	165.1	57.2	6.37	28.1
	x 15	4.44	8.11	0.245	1/8	4.02	0.315	0.615	13/16	9/16	6 1/2	2 1/4	6.37	28.1
	x 19.3	2480	203	5.84	3.18	102	6.48	14.1	19.1	14.3			7.84	29.9
W150 W6	x 13	3.84	7.99	0.230	1/8	4.00	0.255	0.555	3/4	9/16			7.84	29.9
	x 15	1910	200	4.32	3.18	100	5.21	12.8	17.5	12.7			9.61	40.5
	x 10	2.96	7.89	0.170	1/8	3.94	0.205	0.505	11/16	1/2			9.61	40.5
W150 W6	x 37.1	4740	162	8.13	4.76	154	11.6	17.9	23.8	14.3	114.3	88.9	6.68	15.5
	x 25	7.34	6.38	0.320	3/16	6.08	0.455	0.705	15/16	9/16	4 1/2	3 1/2	6.68	15.5
	x 29.8	3790	157	6.60	3.18	153	9.27	15.6	22.2	14.3			8.25	19.1
W150 W6	x 20	5.87	6.20	0.260	1/8	6.02	0.365	0.615	7/8	9/16			8.25	19.1
	x 22.5	2860	152	5.84	3.18	152	6.60	13.0	19.1	14.3			11.5	21.6
	x 15	4.43	5.99	0.230	1/8	5.99	0.260	0.510	3/4	9/16			11.5	21.6
W150 W6	x 24	3060	160	6.60	3.18	102	10.3	16.6	22.2	14.3	114.3	57.2	4.98	19.1
	x 16	4.74	6.28	0.260	1/8	4.03	0.405	0.655	7/8	9/16	4 1/2	2 1/4	4.98	19.1
	x 18	2290	153	5.84	3.18	102	7.11	13.5	19.1	14.3			7.14	21.6
	x 12	3.55	6.03	0.230	1/8	4.00	0.280	0.530	3/4	9/16			7.14	21.6
W150 W6	13.5	1730	150	4.32	3.18	100	5.46	11.8	17.5	12.7			9.16	29.2
	x 9	2.68	5.90	0.170	1/8	3.94	0.215	0.465	11/16	1/2			9.16	29.2
	x 13	1630	148	4.32	3.18	100	4.95	11.3	17.5	12.7			10.1	29.1
W130 W5	x 8.5	2.52	5.83	0.170	1/8	3.94	0.195	0.445	11/16	1/2			10.1	29.1
	x 28.1	3590	131	6.86	3.18	128	10.9	18.5	20.6	11.1	88.9	69.9	5.85	13.7
	x 19	5.56	5.15	0.270	1/8	5.03	0.430	0.730	13/16	7/16	3 1/2	2 3/4	5.85	13.7
W130 W5	x 23.8	3040	127	6.10	3.18	127	9.14	16.8	19.1	11.1	88.9	69.9	6.94	15.4
	x 16	4.71	5.01	0.240	1/8	5.00	0.360	0.660	3/4	7/16	3 1/2	2 3/4	6.94	15.4
W100 W4	x 19.3	2470	106	7.11	3.18	103	8.76	15.1	19.1	12.7	66.7	57.2	5.88	10.6
	x 13	3.83	4.16	0.280	1/8	4.06	0.345	0.595	3/4	1/2	2 5/8	2 1/4	5.88	10.6

PERFILES ESTRUCTURALES
VIGAS DE ALA ANCHA

Peso nominal	Eje X-X				Eje Y-Y				rts	ho	Propiedades de torsión		Área de revestimiento
	I	S	r	Z	I	S	r	Z			J	Cw	
	mm ⁴ /10 ⁶ in ⁴	mm ³ /10 ³ in ³	mm in	in ³ mm ³ /10 ³	mm ⁴ /10 ⁶ in ⁴	mm ³ /10 ³ in ³	mm in	mm ³ /10 ³ in ³			mm in	mm in	
100 67	113 272	990 60.4	94.5 3.72	1150 70.1	36.9 88.6	351 21.4	53.8 2.12	536 32.7	61.7 2.43	205 8.07	2100 5.05	387 1440	1.27 4.17
86 58	94.9 228	852 52.0	92.7 3.65	980 59.8	31.3 75.1	300 18.3	53.3 2.10	457 27.9	60.7 2.39	202 7.94	1390 3.33	317 1180	1.25 4.11
71 48	76.6 184	708 43.2	91.7 3.61	803 49.0	25.3 60.9	246 15.0	52.8 2.08	375 22.9	59.7 2.35	199 7.82	816 1.96	250 931	1.24 4.05
59 40	60.8 146	582 35.5	89.7 3.53	652 39.8	20.4 49.1	200 12.2	51.8 2.04	303 18.5	58.7 2.31	195 7.69	466 1.12	195 726	1.22 4.01
52 35	52.9 127	511 31.2	89.2 3.51	569 34.7	17.7 42.6	174 10.6	51.6 2.03	264 16.1	57.9 2.28	194 7.63	320 0.769	166 619	1.21 3.98
46.1 31	45.8 110	451 27.5	88.1 3.47	498 30.4	15.4 37.1	152 9.27	51.3 2.02	231 14.1	57.4 2.26	192 7.57	223 0.536	142 530	1.20 3.95
41.7 28	40.8 98.0	398 24.3	87.6 3.45	446 27.2	9.03 21.7	109 6.63	41.1 1.62	166 10.1	46.7 1.84	193 7.60	224 0.537	83.8 312	1.06 3.48
35.9 24	34.4 82.7	342 20.9	86.9 3.42	379 23.1	7.62 18.3	92.3 5.63	40.9 1.61	140 8.57	46.0 1.81	191 7.53	144 0.346	69.6 259	1.05 3.45
31.3 21	31.3 75.3	298 18.2	88.6 3.49	334 20.4	4.07 9.77	60.8 3.71	32.0 1.26	93.2 5.69	37.1 1.46	200 7.88	117 0.282	40.8 152	0.94 3.10
26.6 18	25.8 61.9	249 15.2	87.1 3.43	279 17.0	3.32 7.97	49.8 3.04	31.2 1.23	76.4 4.66	36.3 1.43	198 7.81	71.6 0.172	32.8 122	0.94 3.07
22.5 15	20.0 48.0	193 11.8	83.6 3.29	223 13.6	1.42 3.41	279 1.70	22.3 0.876	43.8 2.67	26.9 1.06	198 7.80	57.0 0.137	13.9 51.8	0.81 2.65
19.3 13	16.5 39.6	162 9.91	81.5 3.21	187 11.4	1.14 2.73	22.5 1.37	21.4 0.843	35.2 2.15	26.2 1.03	197 7.74	36.3 0.087	11.0 40.8	0.80 2.63
15 10	12.8 30.8	128 7.81	81.8 3.22	145 8.87	0.870 2.09	17.4 1.06	21.4 0.841	27.2 1.66	25.7 1.01	195 7.69	17.7 0.043	8.30 30.9	0.79 2.60
37.1 25	22.2 53.4	274 16.7	68.6 2.70	310 18.9	7.12 17.1	91.9 5.61	38.6 1.52	140 8.56	44.2 1.74	151 5.93	192 0.461	40.3 150	0.93 3.04
29.8 20	17.2 41.4	220 13.4	67.6 2.66	246 15.0	5.54 13.3	72.3 4.41	38.1 1.50	110 6.72	43.2 1.70	148 5.84	99.9 0.240	30.3 113	0.91 3.00
22.5 15	12.1 29.1	159 9.72	65.0 2.56	177 10.8	3.88 9.32	51.0 3.11	36.8 1.45	77.8 4.75	42.2 1.66	146 5.73	42.0 0.101	20.5 76.5	0.90 2.96
24 16	13.4 32.1	167 10.2	66.0 2.60	192 11.7	1.84 4.43	36.1 2.20	24.6 0.967	55.6 3.39	28.7 1.13	149 5.88	92.8 0.223	10.3 38.2	0.72 2.35
18 12	9.20 22.1	120 7.31	63.2 2.49	136 8.30	1.24 2.99	24.6 1.50	23.3 0.918	38.0 2.32	27.4 1.08	146 5.75	37.6 0.090	6.63 24.7	0.70 2.30
13.5 9	6.83 16.4	91.1 5.56	62.7 2.47	102 6.23	0.916 2.20	18.2 1.11	23.0 0.905	28.2 1.72	26.9 1.06	145 5.69	16.9 0.041	4.75 17.7	0.69 2.27
13 8.5	6.20 14.9	83.6 5.10	61.7 2.43	93.9 5.73	0.828 1.99	16.6 1.01	22.6 0.890	25.6 1.56	26.7 1.05	143 5.64	13.9 0.033	4.24 15.8	0.69 2.26
28.1 19	10.9 26.3	167 10.2	55.1 2.17	190 11.6	3.80 9.13	59.5 3.63	32.5 1.28	90.6 5.53	36.8 1.45	120 4.72	132 0.316	13.7 50.9	0.76 2.49
23.8 16	8.91 21.4	140 8.55	54.1 2.13	158 9.63	3.13 7.51	49.2 3.00	32.0 1.26	75.1 4.58	36.3 1.43	118 4.65	79.9 0.192	10.9 40.6	0.75 2.46
19.3 13	4.70 11.3	89.5 5.46	43.7 1.72	103 6.28	1.61 3.86	31.1 1.90	25.4 1.00	47.9 2.92	29.5 1.16	97 3.82	62.9 0.151	3.76 14.0	0.61 2.00

PERFILES ESTRUCTURALES

CANALES

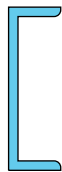

GRADOS DE ACERO DISPONIBLES

ESTADOUNIDENSE		
ASTM	LÍMITE ELÁSTICO	
	MPa	ksi
A 36	250	36
A 572 Grado 50	345	50
A 572 Grado 60	415	60
A 588	345	50
A 242	345	50

CANADIENSE		
CSA G40.21	LÍMITE ELÁSTICO	
	MPa	ksi
Grado 350 W	350	50

TOLERANCIAS DE ENTREGA

Peso	± 2.5%	
Peralte		
De 7.62cm a 1778cm	+ 0.09375cm	- 0.1588cm
De 17.8cm a 35.6cm	+ 0.3175cm	- 0.2381cm
Más de 35.6cm	+ 0.4763cm	- 0.3175cm
Longitud		
De 1.5m a 3.0m	+ 2.54cm	
De 3m a 6.1m	+ 3.81cm	
De 6.1m a 9.1m	+ 4.45cm	
De 9.1m a 12.1m	+ 5.72cm	
De 12.1m a 15.1m	+ 6.99cm	
De 15.1m a 19.7m	+ 6.99cm	
Ancho de patín		
De 7.62cm a 1778cm	± 0.318cm	
De 17.8cm a 35.6cm	+ 0.3175cm	- 2.3813cm
Más de 35.6cm	+ 0.3175cm	- 0.4763cm
Patines descuadrados	≤ 0.07938cm	
Inclinación	(0.3175cm) * (Ancho del par / 5)	
Barrido	Sujeto a negociación con el fabricante.	

LONGITUDES MÁXIMAS**

Todas las secciones	18.29m	60 ft
La mayoría de las secciones	25.91m	85 ft
Algunas secciones	36.58m	130 ft

** Es posible fabricar en longitudes mayores a pedido.

ÁNGULOS

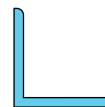

GRADOS DE ACERO DISPONIBLES

ESTADOUNIDENSE		
ASTM	LÍMITE ELÁSTICO	
	MPa	ksi
A 36	250	36
A 572 Grado 50	345	50
A 572 Grado 60	415	60
A 588	345	50
A 242	345	50

CANADIENSE		
CSA G40.21	LÍMITE ELÁSTICO	
	MPa	ksi
Grado 350 W	350	50

TOLERANCIAS DE ENTREGA

Peso	± 2.5%	
Longitud		
De 1.5m a 3.0m	+ 2.54cm	
De 3.0m a 6.1m	+ 3.81cm	
De 6.1m a 9.1m	+ 4.44cm	
De 9.1m a 12.1m	+ 5.71cm	
De 12.1m a 15.1m	+ 6.98cm	
De 15.1m a 19.7m	+ 6.98cm	
Longitud de soporte *		
De 2.54cm a 5.08cm	± 0.119cm	
De 5.08cm a 7.62cm	± 0.159cm	
De 7.62cm a 10.16cm	+ 0.317cm	- 0.288cm
De 10.16cm a 15.24cm	± 0.318cm	
Más de 15.24cm	+ 0.4763cm	- 0.318cm
Patines descuadrados	± 1.5 grados	
Espesor	De 2.54cm a 5.08cm	De 5.08cm a 7.62cm.
≤ 0.476cm	± 0.025cm	± 0.031cm
De 0.476cm a 0.953cm	± 0.025cm	± 0.038cm
Más de 0.953cm	± 0.031cm	± 0.038cm.
Inclinación	(0.3175cm) * (Ancho del par / 5)	
Barrido	Sujeto a disponibilidad	

* La mayor longitud de soporte determina la clasificación.

LONGITUDES MÁXIMAS**

Todas las secciones	18.29m	60 ft
La mayoría de las secciones	25.91m	85 ft
Algunas secciones	36.58m	130 ft

** Es posible fabricar en longitudes mayores a pedido.

ACCESORIOS DE PILOTES

Debido a que la exploración geotécnica y la hinca de pilotes no son ciencias exactas, es un reto estimar la hincabilidad de los pilotes y determinar sus longitudes finales. A fin de asistir a los ingenieros y contratistas en la construcción de cimentaciones profundas, se encuentran disponibles empalmadoras de pilotes, bases, zapatas y otros accesorios.

Aplicaciones de accesorios de pilotes

Los empalmes prefabricados se utilizan para unir pilotes de acero. Se utilizan en situaciones donde las longitudes finales de los pilotes necesitan ser más largas de lo que se pueda manejar y entregar en el proyecto, o en aplicaciones de escasa altura libre para maniobras. Las zapatas y puntas de hincado protegen los extremos de los pilotes, facilitan la instalación y en el caso de tuberías, evitan que entre material para que estos puedan ser llenados con concreto. También están disponibles pilotes esquineros moldeados para facilitar la construcción de muros de tablestacas. Los accesorios de pilotes se pueden hacer a la medida para satisfacer cualquier requerimiento.



Punta protectora de tablestacas



Zapatas de corte de extremo abierto



Empalmadora HP

ACCESORIOS PARA TABLESTACAS

ACCESORIOS HP



Punta HP



Empalmadora HP



Punta HP



Punta HP

ACCESORIOS PARA TABLESTACAS DE ACERO



Punta protectora de tablestacas



Protector de tablestacas

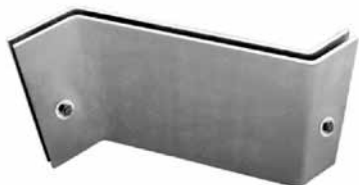

Punta protectora de tablestacas



Filtro de jet

ACCESORIOS PARA TABLESTACAS

ACCESORIOS DE TUBERÍAS

Zapatas de corte de extremo abierto



Zapatas exterior



Zapatas interior

Empalme a compresión para pilotes tubulares



Puntas cónicas



Brida interior (60°)



Brida interior (60°)

Obturador a presión Drive-Tite



Anillo de apoyo

ACCESORIOS PARA PILOTES DE MADERA



Punta protectora tipo bota



Punta protectora sombrero



Timber Uplift Connector

INFORMACIÓN DE CONTACTO

Associated Pile & Fitting Corporation
Tel: (973) 773-8400
Línea sin costo de asistencia: +1 800 526-9047
Fax: (973) 428-5146
apf@associatedpile.com
www.associatedpile.com

SOLUCIONES GEOESTRUCTURALES

En nuestra calidad de proveedor de primera línea de productos para cimentaciones de acero, con orgullo le presentamos nuestra nueva línea integral de productos geoestructurales.

Desde que formamos parte de la familia Nucor, se ha hecho un énfasis concentrado tendiente a desarrollar plenamente la unidad de negocios geoestructurales para convertirla en un líder en el campo del suministro para los negocios dedicados a la construcción civil pesada.

Se ha conjuntado a un grupo medular de especialistas de la industria geoestructural enfocado en la provisión de servicios de alta calidad a este mercado creciente. Se han hecho inversiones considerables en el campo de la fabricación, lo cual nos ha permitido agregar nuevas líneas de productos y fortalecer nuestra oferta actual de productos.

Además de la línea completa de Nucor Skyline consistente de barras roscadas laminadas en frío calibres 75 y 150, ahora ofrecemos una barra mejorada laminada en caliente totalmente roscada. También hemos ampliado nuestras capacidades de fabricación, lo cual nos permite producir anclajes DCP enlechados en planta y anclajes SCP para el suelo en múltiples puntos distribuidos a lo largo de los Estados Unidos. El equipo experimentado del área de producción de Nucor Skyline se ha convertido en un grupo de expertos en el ensamblado a gran escala de jaulas de barras de refuerzo, mediante el uso de acopladores y tuercas de carga completa con dimensiones que exceden los 65' de largo.

También se han hecho mejoras importantes en nuestras capacidades de fabricación de micropilotes. Para complementar de manera adicional nuestra línea completa de productos de varillas de refuerzo, se amplió la capacidad de producción de encofrados con micropilotes roscados, esto nos posiciona como la única fuente de suministro para cualquier contratista que aborde un proyecto con micropilotes. Ahora Nucor Skyline cuenta con anclajes multi-trenzados que ofrecen las ventajas de los sistemas de anclajes distribuidores de carga Samwoo, con capacidades de que se les puede retirar. También hemos agregado a nuestra oferta de productos geoestructurales, un sistema integral de barras huecas con una línea completa de accesorios complementarios. Nucor Skyline goza del placer de ser un líder en el mercado de productos geoestructurales; además, estamos dedicados a asociarnos con nuestros clientes y a entregar productos y soluciones económicamente viables de alta calidad.



New York, NY



Chicago, IL

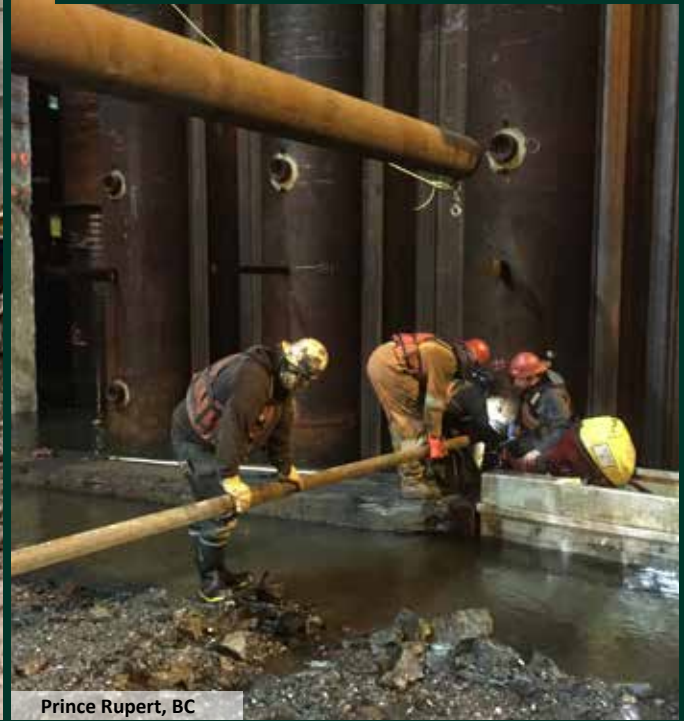

Prince Rupert, BC

GRADO DE ACERO DE REFUERZO / LAMINADAS EN FRÍO

BARRA COMPLETAMENTE ROSCADA

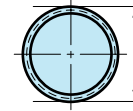
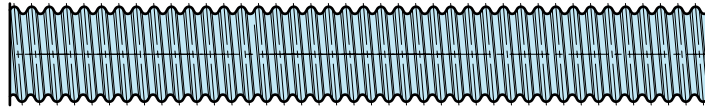

Diámetro externo
aproximado de la rosca

Grado 80 ksi límite elástico / 100 ksi fuerza final									
Designación de la barra	Diámetro nominal	Grado	Área neta mínima entre roscas	Resistencia final mínima	Límite de elástico mínimo	Peso nominal	Diámetro mayor de rosca aproximado	Orientación de la rosca	Longitud máxima
	mm in		mm ² in ²	kN kips	kN kips	kg/m lbs/ft	mm in		m ft
#10	32 1 ¼	80	819.0 1.270	565 127.0	452 101.6	6.4 4.30	35.0 1.375	Mano izquierda	18.3 60
#11	35 1 ½	80	1006.0 1.560	670 156.0	555 124.8	7.9 5.30	38.1 1.500	Mano izquierda	18.3 60
#14	45 1 ¾	80	1452.0 2.250	1001 225.0	801 180.0	11.4 7.65	47.6 1.875	Mano derecha	18.3 60
#18	55 2 ¼	80	2581.0 4.000	1779 400.0	1423 320.0	20.2 13.60	62.0 2.438	Mano derecha	18.3 60
#20	64 2 ½	80	3168.0 4.910	2184 491.0	1747 392.8	24.8 16.69	70.0 2.750	Mano derecha	18.3 60
#24	76 3	80	4561.0 7.070	3145 707.0	2516 565.6	35.9 24.10	82.6 3.250	Mano derecha	18.3 60
#28	89 3 ½	80	6200.0 9.610	4275 961.0	3420 768.8	48.7 32.70	95.3 3.750	Mano derecha	18.3 60

† Las barras roscadas laminadas en frío se ajustan a los requisitos físicos y químicos de ASTM A 615 grado 75 ksi "Especificación estándar para barras de acero de carbono deformadas para refuerzo de concreto"
* Comuníquese con su representante local de Nucor Skyline para obtener información sobre grados de acero adicionales.

BARRA COMPLETAMENTE ROSCADA

CONECTORES PARA BARRAS ROSCADAS

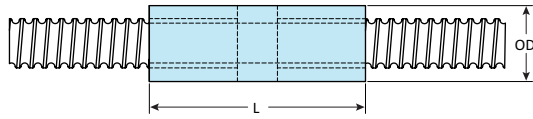

TUERCAS HEXAGONALES (COMPLETAS Y DE AJUSTE)

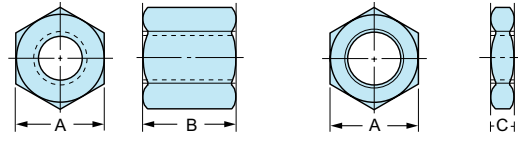

Tuercas hexagonales completas

Tuercas hexagonales de ajuste

Barra grado 80 – ASTM A108 / A576			
Designación de la barra	OD	L	Peso
	mm in	mm in	kg lb
#10	54.0 2.125	139.7 5.500	1.57 3.47
#11	57.2 2.250	152.4 6.000	1.82 4.02
#14	73.0 2.875	200.0 7.875	4.15 9.16
#18	88.9 3.500	231.8 9.125	6.32 13.93
#20	101.6 4.000	241.3 9.500	9.01 19.86
#24	120.6 4.750	243.0 10.750	14.07 31.01
#28	139.7 5.500	304.8 12.000	20.96 46.20

Barra grado 80 – ASTM A108 / A576**					
Designación de la barra	A mm in	B mm in	C mm in	Peso	
				kg / lb	
				Completas	Ajuste
#10	50.8 2.000	55.5 2.187	15.9 0.625	0.60 1.33	0.17 0.38
#11	57.2 2.250	63.5 2.500	17.5 0.688	0.89 1.96	0.24 0.54
#14	69.9 2.750	82.6 3.250	23.8 0.938	1.75 3.86	0.50 1.11
#18	89.0 3.500	89.0 3.500	25.4 1.000	2.21 4.87	0.82 1.81
#20*	101.6 4.000	114.3 4.500	28.6 1.125	4.46 9.83	1.25 2.76
#24**	120.6 4.750	114.3 4.500	38.1 1.500	5.89 12.98	1.96 4.33
#28**	139.7 5.500	152.4 6.000	39.7 1.563	10.48 23.10	2.73 6.02

*Tuercas de collar redondeado disponible **Tuercas de collar redondeado con planos

ARANDELAS TEMPLADAS

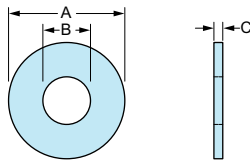

ARANDELAS REDONDAS BISELADAS

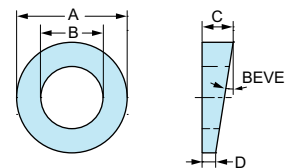

Barra grado 80 – ASTM F436				
Designación de la barra	A	B	C	Peso
	mm in	mm in	mm in	kg lb
#10	69.85 2.75	38.887 1.531	3.454 0.136	0.07 0.160
#11	76.20 3.00	41.275 1.625	3.454 0.136	0.09 0.190
#14	95.25 3.75	53.975 2.125	4.521 0.178	0.17 0.380
#18	114.30 4.50	67.488 2.657	6.096 0.240	0.32 0.710
#20	139.70 5.50	80.188 3.157	6.096 0.240	0.49 1.09
#24	152.40 6.00	92.075 3.625	9.525 0.375	0.87 1.910
#28	177.80 7.00	104.775 4.125	9.525 0.375	1.22 2.680

Barra grado 80 – ASTM F436 / A536, 80-55-06 Fundición dúctil						
Designación de la barra	A mm in	B mm in	C mm in	D mm in	Biselado grados	Peso
						kg lb
#10	69.85 2.75	41.40 1.63	24.64 0.97	5.84 0.23	15	0.30 0.66
#11	78.49 3.09	44.45 1.75	26.92 1.06	5.84 0.23	15	0.45 0.93
#14	101.60 4.00	54.10 2.13	32.77 1.29	5.84 0.23	15	0.88 1.94
#18	116.84 4.60	66.80 2.63	29.97 1.18	9.40 0.37	10	1.12 2.46
#20	127.00 5.00	76.20 3.00	33.27 1.31	10.92 0.43	10	1.41 3.10
#24	203.20 8.00	88.90 3.50	44.45 1.75	10.92 0.43	10	5.71 12.58
#28	203.20 8.00	101.60 4.00	57.15 2.25	21.34 0.84	10	7.50 16.54

NOTA: Los acopladores están disponibles como "tipo tope" o "de paso". Los acopladores pasantes requieren que las barras se aprieten entre sí en el punto medio del acoplador y se fijen con tornillos de fijación o contratuercas para asegurar un enganche adecuado.

Tome en cuenta: Ya que mejoramos continuamente el diseño de nuestros productos, la información de los productos está sujeta a cambio.

† Comuníquese con su representante de ventas para obtener información acerca de las barras galvanizadas fundidas en caliente y las barras con recubrimiento epóxico.

GRADO DE ACERO DE REFUERZO / LAMINADAS EN FRÍO BARRA COMPLETAMENTE ROSCADA

PLACAS DE CARGA

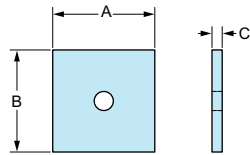

TENSOR

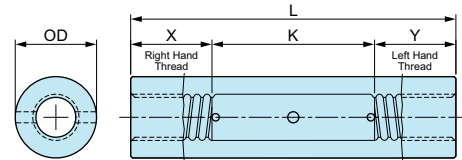

Barra grado 75 - A 572 (Grado 50 - A 588)				
Designación de la barra	A mm in	B mm in	C mm in	Peso kg lb
#10	203.2 8	203.2 8	25.40 1	8.04 17.73
#11	254.0 10	254.0 10	25.40 1	12.64 27.86
#14	254.0 10	254.0 10	38.10 1½	18.76 41.37
#18	254.0 10	254.0 10	50.80 2	24.59 54.21
#20	254.0 10	254.0 10	63.50 2½	30.42 67.06
#24	254.0 10	254.0 10	63.50 2½	29.69 65.46
#28	304.8 12	304.8 12	69.85 2¾	47.29 104.26

Tome en cuenta: Ya que mejoramos continuamente el diseño de nuestros productos, la información de los productos está sujeta a cambio.

Designación de la barra	OD mm in	L mm in	X mm in	Y mm in	K mm in
#10	54.0 2.125	312.4 12.3	57.2 2.25	57.2 2.25	196.9 7.75
#11	57.1 2.250	330.2 13.0	69.9 2.75	69.9 2.75	196.9 7.75
#14	76.2 3.000	355.6 14.0	82.6 3.25	82.6 3.25	190.5 7.50
#18	88.9 3.500	419.1 16.5	88.9 3.50	88.9 3.50	241.3 9.50
#20	101.6 4.000	533.4 21.0	114.3 4.50	114.3 4.50	304.8 12.0
#24	120.7 4.750	546.1 21.5	120.7 4.75	120.7 4.75	304.8 12.0
#28	139.7 5.500	609.6 24.0	152.4 6.00	152.4 6.00	304.8 12.0

Nota: Solo los hilos laminados en frío son adecuados para usar con tensores. La dirección del hilo en las barras debe ser opuesta entre sí para que el tensor funcione.

TUERCAS CIEGAS PLÁSTICAS DE HDPE*

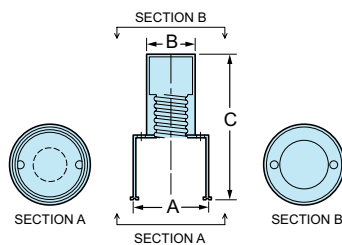

Tuercas ciegas plásticas para barras grados 80			
Designación de la barra	A mm in	B mm in	C mm in
#8 - #11	88.9 3.5	57.2 2.25	171.5 6.75
#14 - #28	165.1 6.5	108.0 4.25	260.4 10.25

* Sello de empaque en la base de la tuerca ciega.

Tome en cuenta: Ya que mejoramos continuamente el diseño de nuestros productos, la información de los productos está sujeta a cambio. Consulte con su representante de ventas en cuanto a la disponibilidad de diferentes grados.

BARRA COMPLETAMENTE ROSCADA

OJALES FORJADOS

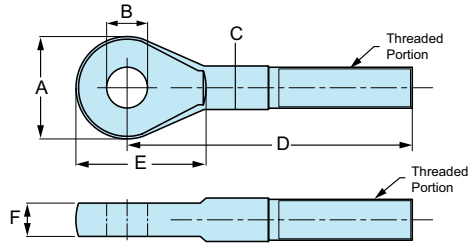

Designación de la barra	A	B	C	D	E	F
	mm in	mm in	mm in	mm in	mm in	mm in
#14	155 6.1	63 2.5	60 2.4	505 19.9	207 8.1	50 2.0
#18	155 6.1	63 2.5	60 2.4	505 19.9	207 8.1	50 2.0
#20	180 7.1	76 3.0	76 3.0	520 20.5	248 9.8	63 2.5
#24	180 7.1	76 3.0	76 3.0	520 20.5	248 9.8	63 2.5
#28	230 9.2	88 3.5	90 3.5	565 22.2	312 12.3	75 3.0

Las roscas en los ojales forjados serán métricas. Hay disponibles acopladores de conversión (transición) para todas las formas de rosca de Nucor Skyline. Comuníquese con su representante de ventas de Nucor Skyline para obtener ayuda en los detalles de la conexión.

COUPLE DE TRANSICIÓN PARA BARRAS DE OJAL FORJADO

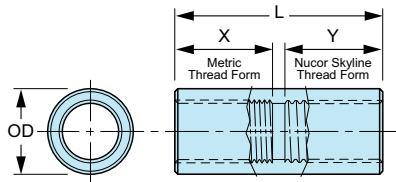

Designación de la barra	OD	L	X	Y	Peso
	mm in	mm in	mm in	mm in	kg (lb)
M56 - #14	88.90 3.50	248.92 9.8	101.6 4.00	116.0 4.57	8.4 18.4
M56 - #18	88.90 3.50	248.92 9.8	101.6 4.00	116.0 4.57	7.1 15.6
M72 - #20	120.65 4.75	304.80 12.0	136.5 5.38	136.5 5.38	17.8 39.2
M72 - #24	120.65 4.75	304.80 12.0	136.5 5.38	136.5 5.38	15.8 34.9
M85 - #28	139.70 5.50	337.82 13.3	152.4 6.00	152.4 6.00	22.0 48.5

PROTECCIÓN CONTRA LA CORROSIÓN



Todas las barras roscadas se pueden suministrar con una cubierta de tubo de PVC de paredes suaves. A pesar de que el tubo de PVC es de 0.001 mm de grosor, se encuentran disponibles otras opciones a solicitud.

También están disponibles las siguientes opciones adicionales de protección contra la corrosión para todas las barras roscadas:

Protección única contra la corrosión (PUC)

Protección Doble Contra la Corrosión (PDC)

- Encapsulamiento: grasa o lechada
- Galvanización
- Recubrimiento de epóxico
- Pintura
- Enchapado
- Cinta protectora

Se proporcionan accesorios de tamaño extra para acomodar las barras galvanizadas y recubiertas.

Comuníquese con su representante de soluciones geo-estructurales de Nucor Skyline para obtener recomendaciones acerca del sistema que se adecuará mejor a sus requisitos.

GRADO DE ACERO DE REFUERZO / LAMINADAS EN CALIENTE

BARRA COMPLETAMENTE ROSCADA

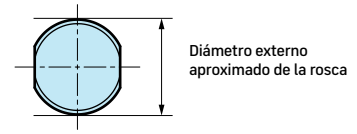
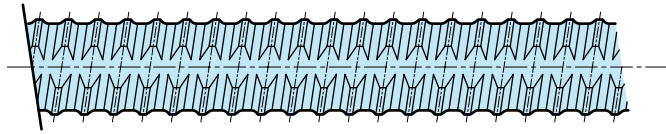

Grado 80 ksi límite elástico / 100 ksi fuerza final

Designación de la barra	Grado	Diámetro nominal		Área neta mínima entre rosas		Resistencia final mínima		Límite de elástico mínimo		Orientación de la rosca	Longitud máxima
		mm	in	mm ²	in ²	kN	kips	kN	kips		
#6	80	20	3/4	284	0.44	196	44	157	35.2	Mano izquierda	18 60
#7	80	22	7/8	387	0.60	267	60	214	48.0	Mano izquierda	18 60
#8	80	25	1	510	0.79	351	79	281	63.2	Mano izquierda	18 60
#9	80	28	1 1/4	645	1.00	449	100	356	80.0	Mano izquierda	18 60
#10	80	32	1 1/4	819	1.27	565	127	452	101.6	Mano izquierda	18 60
#11	80	35	1 3/8	1006	1.56	694	156	555	124.8	Mano izquierda	18 60
#14	80	45	1 3/4	1452	2.25	1001	225	801	180.0	Mano derecha	18 60
#18	80	55	2 1/4	2581	4.00	1779	400	1423	320.0	Mano derecha	18 60
#20	80	64	2 1/2	1452.00	2.25	1152	259	1747	392.8	Mano derecha	18 60

Las barras roscadas laminadas en caliente cumplen con los requerimientos de la ASTM A 615 para Calibres de 100 ksi "Especificación Estándar para Barras de Acero al Carbón Deformadas, para Refuerzos de Concreto"

Grado 100 ksi límite elástico / 115 ksi fuerza final

Designación de la barra	Grado	Diámetro nominal		Área neta mínima entre rosas		Resistencia final mínima		Límite de elástico mínimo		Orientación de la rosca	Longitud máxima
		mm	in	mm ²	in ²	kN	kips	kN	kips		
#11	100	35	1 3/8	1006	1.56	798	179.4	670	156.0	Mano izquierda	18.3 60
#14	100	45	1 3/4	1452	2.25	1150	258.6	1001	225.0	Mano derecha	18.3 60
#18	100	55	2 1/4	2581	4.00	2046	460.0	1779	400.0	Mano derecha	18.3 60
#20	100	64	2 1/2	3168	4.91	2512	564.7	2184	491.0	Mano izquierda	18.3 60

Las barras roscadas laminadas en caliente cumplen con los requerimientos de la ASTM A 615 para Calibres de 100 ksi "Especificación Estándar para Barras de Acero al Carbón Deformadas, para Refuerzos de Concreto"

BARRA COMPLETAMENTE ROSCADA

COUPLER

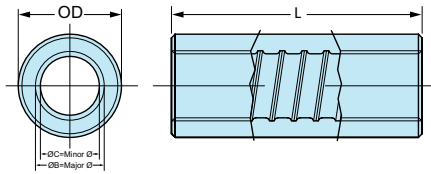

TUERCAS HEXAGONALES (COMPLETAS Y DE AJUSTE)

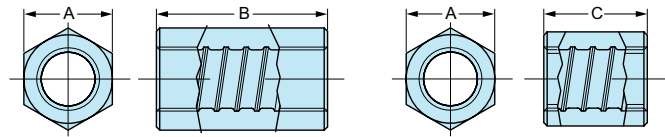

Barra grado 80/100 – ASTM A576, A108					
Designación de la barra	Diámetro nominal	OD	L	Peso	
				in	lbs
				mm	kg
#6	¾ 20	1.25 31.75	3.125 79.37	0.62 0.28	
#7	¾ 22	1.50 38.10	3.75 95.25	0.93 0.42	
#8	1 25	1.625 41.27	4.00 101.60	1.37 0.62	
#9	1¼ 28	1.875 47.62	5.00 127.00	2.31 1.05	
#10	1¼ 32	2.00 50.80	5.75 146.05	2.77 1.26	
#11	1½ 35	2.25 57.15	6.40 162.56	3.79 1.72	
#14	1½ 45	2.88 73.15	7.85 192.53	5.49 2.49	
#18	2¼ 55	3.75 95.25	12.00 304.8	21.9 9.93	
#20	2½ 64	4.25 107.95	10.15 257.81	25.1 11.39	

Barra grado 80/100 – ASTM A576, A108						
Designación de la barra	Diámetro nominal	A	B	C	Peso	
					in	lb / kg
					mm	Completas
#6	¾ 20	1.125 28.57	1.45 36.83	0.87 22.10	0.26 0.12	0.16 0.07
#7	¾ 22	34.92 1.375	44.45 1.75	22.10 0.87	0.20 0.43	0.10 0.21
#8	26 1	41.3 1.625	50.8 2.00	12.7 0.500	0.37 0.81	0.09 0.20
#9	32 1¼	44.5 1.750	50.8 2.00	14.3 0.563	0.40 0.89	0.11 0.25
#10	36 1½	50.8 2.000	55.5 2.187	15.9 0.625	0.60 1.33	0.17 0.38
#11	46 1¾	57.2 2.250	63.5 2.500	17.5 0.688	0.89 1.96	0.24 0.54
#14	57 2¼	69.9 2.750	82.6 3.250	23.8 0.938	1.75 3.86	0.50 1.11
#18	65 2½	89.0 3.500	89.0 3.500	25.4 1.000	2.21 4.87	0.82 1.81
#20*	75 3*	101.6 4.000	114.3 4.500	28.6 1.125	4.46 9.83	1.25 2.76

*Tuerca de collar redondeado disponible **Tuerca de collar redondeado con planos

ARANDELAS TEMPLADAS

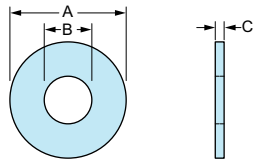

Barra grado 80/100 – ASTM F436						
Designación de la barra	Diámetro nominal	A	B	C	Peso	
					in	lbs
					mm	kg
#6	¾ 20	1.75 44.45	0.938 23.83	.136 3.45	0.07 0.03	
#7	¾ 22	2.00 50.80	1.063 27.00	.136 3.45	0.09 0.04	
#8	1 25	2.25 57.15	1.188 30.18	.136 3.45	0.11 0.05	
#9	1¼ 28	2.50 63.50	1.375 34.92	.136 3.45	0.13 0.06	
#10	1¼ 32	2.75 69.85	1.531 38.89	.136 3.45	0.16 0.07	
#11	1½ 35	3.00 76.20	1.625 41.27	.136 3.45	0.19 0.09	
#14	1½ 45	3.75 95.25	2.125 53.975	.178 4.521	0.38 0.17	
#18	2¼ 55	6.00 152.40	3.625 92.075	.375 9.525	1.91 0.87	
#20	2½ 64	7.00 177.80	4.125 104.775	.375 9.525	2.68 1.22	

ARANDELAS REDONDAS BISELADAS

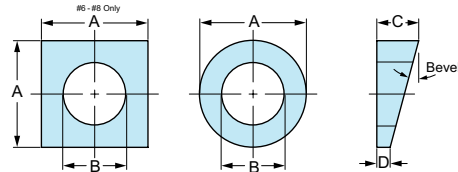

Barra grado 80/100 – F 436, A536 80-55-06								
Designación de la barra	Diámetro nominal	A	B	C	D	Biselado	Peso	
							in	lbs
							mm	kg
#6	¾ 20	1.75 44.45	.95 24.13	.78 19.81	.32 8.13	15	.32 0.15	
#7	¾ 22	1.75 44.45	1.14 28.96	.78 19.81	.32 8.13	15	.37 0.17	
#8	1 25	1.75 44.45	1.14 28.96	.78 19.81	.23 5.84	15	.37 0.17	
#9	1¼ 28	2.63 66.80	1.38 31.75	.93 23.62	.23 5.84	15	.64 0.29	
#10	1¼ 32	2.75 69.85	1.63 41.40	.97 24.64	.23 5.84	15	.66 0.30	
#11	1½ 35	3.09 78.49	1.75 44.45	1.06 26.92	.23 5.84	15	.93 0.45	
#14	1½ 45	4.00 101.6	2.13 54.10	1.29 32.77	.23 5.84	15	1.94 0.88	
#18	2¼ 55	8.00 203.20	3.50 88.90	1.75 44.45	.43 10.92	10	12.58 5.71	
#20	2½ 64	8.00 203.20	4.00 101.60	2.25 57.15	.84 21.34	10	16.54 7.50	

Tome en cuenta: Ya que mejoramos continuamente el diseño de nuestros productos, la información de los productos está sujeta a cambio.

† Comuníquese con su representante de ventas para obtener información acerca de las barras galvanizadas fundidas en caliente y las barras con recubrimiento epóxico.

ACERO DE ALTA RESISTENCIA / LAMINADAS EN FRÍO

BARRA COMPLETAMENTE ROSCADA

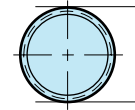
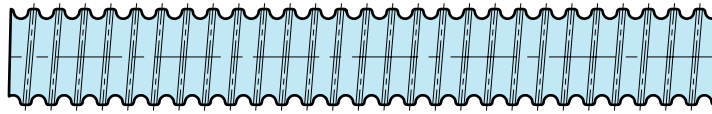

Diámetro externo
aproximado de la rosca

Grade 120 ksi Yield Strength / Grade 150 ksi Ultimate Strength								
Diámetro nominal	Grado	Área neta mínima entre roscas	Resistencia final mínima	Límite de elástico mínimo	Peso nominal	Diámetro mayor aproximado de la rosca	Orientación de la rosca	Longitud máxima
1 26	150	0.850 549	128 567	102 454	3.1 4.6	1 1/8 28.6	Mano izquierda	60 18.3
1 1/4 32	150	1.250 807	188 834	150 667	4.5 6.7	1 1/2 38.1	Mano izquierda	60 18.3
1 3/8 36	150	1.580 1019	237 1054	190 843	5.7 8.5	1 5/8 41.3	Mano izquierda	60 18.3
1 3/4 46	150	2.600 1677	390 1735	320 1423	9.1 13.5	2 50.8	Mano izquierda	60 18.3
2 1/4 57	150	4.000 2581	600 2669	480 2135	13.6 20.2	2 1/16 62.0	Mano izquierda	60 18.3
2 1/2 65	150	5.190 3350	778 3457	622 2766	18.3 27.2	2 3/4 69.9	Mano izquierda	60 18.3
3 75	150	7.060 4554	1059 4702	847 3766	24.0 35.7	3 1/4 82.6	Mano izquierda	60 18.3

La barra roscada de alta resistencia de Nucor Skyline es redonda lisa de grado 4140 roscada en frío, templada y revenida.

ANCHOR NUTS[†]

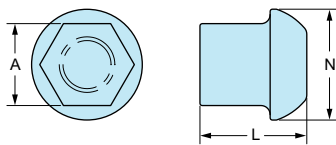

Anchor Nuts para acero de alta resistencia - ASTM A 788				
Diámetro	A	L	N	Peso
mm in	mm in	mm in	mm in	kg lb
26 1	44.5 1.750	59.9 2.360	62.2 2.45	0.65 1.44
32 1 1/4	54.0 2.125	79.5 3.125	80.0 3.15	1.37 3.03
36 1 3/8	60.3 2.375	85.9 3.375	88.9 3.5	1.84 4.05
46 1 3/4	76.2 3.000	101.6 4.000	106.7 4.2	3.20 7.05
57 2 1/4	108.0 4.250	139.7 5.500	142.2 5.6	9.18 20.24

[†] Consulte con su representante de ventas en cuanto a la disponibilidad de diferentes roscas y grados.

TUERCAS CIEGAS PLÁSTICAS DE HDPE*

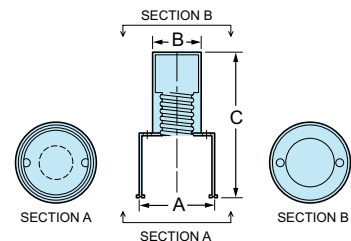

Tuercas ciegas plásticas para acero de alta resistencia			
Diámetro nominal	A	B	C
mm in	mm in	mm in	mm in
26 - 36 1 - 1 1/4	88.9 3.5	57.2 2.25	171.5 6.75
46 - 75 1 3/4 - 3	165.1 6.5	108.0 4.25	260.4 10.25

* Sello de empaque en la base de la tuerca ciega.

BARRA COMPLETAMENTE ROSCADA

CONECTORES PARA BARRAS ROSCADAS

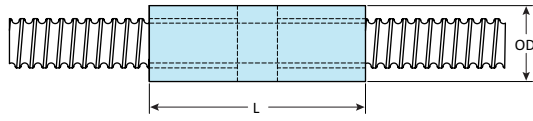

TUERCAS HEXAGONALES (COMPLETAS Y DE AJUSTE)

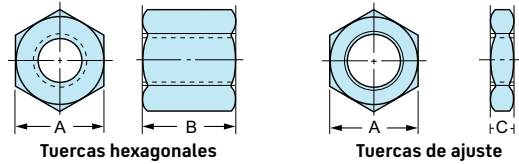

Tuercas hexagonales

Tuercas de ajuste

Barra roscada para acero de alta resistencia – ASTM A108 / A576

Diámetro nominal	OD	L	Peso		
				mm	in
26	44.5	108.0	0.77		
1	1.750	4.250	1.70		
32	54.0	133.4	1.41		
1 1/4	2.125	5.250	3.11		
36	60.3	146.1	1.91		
1 1/2	2.375	5.750	4.22		
46	76.2	215.9	4.53		
1 3/4	3.000	8.500	9.98		
57	101.6	228.6	9.73		
2 1/4	4.000	9.000	21.45		
65	108.0	254.0	10.87		
2 1/2	4.250	10.000	23.96		
75	127.0	308.0	18.71		
3	5.000	12.000	41.24		

Barra roscada para acero de alta resistencia – ASTM A108 / A576

Diámetro nominal	A	B	C	Peso	
				mm	in
20	28.57	36.83	22.10	0.12	0.07
3/4	1.125	1.45	0.87	0.26	0.16
22	34.92	44.45	22.10	0.20	0.10
7/8	1.375	1.75	0.87	0.43	0.21
25	38.10	46.74	22.10	0.25	0.12
1	1.50	1.84	0.87	0.56	0.26
28	44.45	57.15	22.10	0.43	0.17
1-1/8	1.75	2.25	0.87	0.97	0.37
32	50.80	63.50	25.40	0.65	0.25
1-1/4	2.00	2.50	1.00	1.43	0.56
35	57.15	69.85	25.40	0.69	0.24
1-3/8	2.25	2.75	1.00	1.52	0.53
45	63.50	91.44	25.40	1.37	0.37
1-3/4	2.50	3.60	1.00	3.02	0.82

ARANDELAS TEMPLADAS

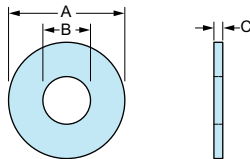

ARANDELAS BISELADAS

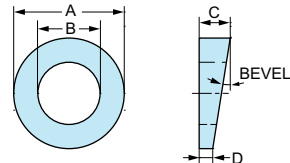

Acero de alta resistencia – ASTM F436

Diámetro nominal	A	B	C	Peso			
					mm	in	mm
20	44.45	23.83	3.45	0.03			
3/4	1.75	0.938	.136	0.07			
22	50.80	27.00	3.45	0.04			
7/8	2.00	1.063	.136	0.09			
25	57.15	30.18	3.45	0.05			
1	2.25	1.188	.136	0.11			
28	63.50	34.92	3.45	0.06			
1-1/8	2.50	1.375	.136	0.13			
32	69.85	38.89	3.45	0.07			
1-1/4	2.75	1.531	.136	0.16			
35	76.20	41.27	3.45	0.09			
1-3/8	3.00	1.625	.136	0.19			
45	82.55	44.96	4.52	0.14			
1-3/4	3.25	1.77	.178	0.30			

Acero de alta resistencia – ASTM F436 / A536, 80-55-06 Ductile Cast Iron

Diámetro nominal	A	B	C	D	Biselado	Peso		
							mm	in
20	44.45	24.13	19.81	8.13	15	0.15		
3/4	1.75	.95	.78	.32		.32		
22	44.45	28.96	19.81	8.13	15	0.17		
7/8	1.75	1.14	.78	.32		.37		
25	44.45	28.96	19.81	5.84	15	0.17		
1	1.75	1.14	.78	.23		.37		
28	66.80	31.75	23.62	5.84	15	0.29		
1-1/8	2.63	1.25	.93	.23		.64		
32	69.85	41.40	24.64	5.84	15	0.30		
1-1/4	2.75	1.63	.97	.23		.66		
35	78.49	44.45	26.92	5.84	15	0.45		
1-3/8	3.09	1.75	1.06	.23		.93		
45	10.16	54.10	32.77	5.84	15	0.88		
1-3/4	4.00	2.13	1.29	.23		1.94		

NOTA: Los acopladores están disponibles como "tipo tope" o "de paso". Los acopladores pasantes requieren que las barras se aprieten entre sí en el punto medio del acoplador y se fijen con tornillos de fijación o contratuercas para asegurar un enganche adecuado.

Nota: Como continuamente mejoramos el diseño de nuestros productos, los detalles del producto están sujetos a cambios.

GRADO COMERCIAL

SISTEMAS DE BARRA HUECA

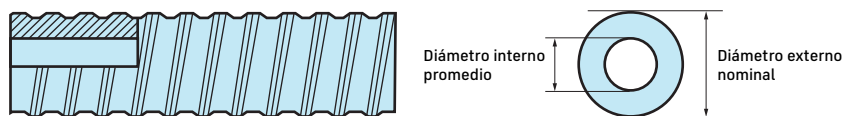

Barra hueca roscada "T"							
Designación de la barra	Diámetro externo nominal	Diámetro interno promedio	Área transversal promedio	Carga máxima	Carga de fluencia	Diámetro mayor aproximado de la rosca	Peso nominal
	mm in	mm in	mm ² in ²	kN kips	kN kips	mm in	kg/m lbs/ft
T40/20	40 1.57	20 0.79	726 1.13	540 121.4	425 95.6	43.2 1.70	5.6 3.8
T40/16	40 1.57	16 0.63	903 1.40	660 148.4	525 118.1	43.2 1.70	7.2 4.8
T52/26	52 2.05	26 1.03	1,251 1.94	925 208.0	756 170.0	55.9 2.20	9.9 6.7
T76N	76 3.00	51 2.00	2,161 3.35	1,418 319	1,120 252.0	81.3 3.20	15.2 10.2
T76S	76 3.00	45 1.77	2,600 4.03	1,859 418	1,467 330.0	81.3 3.20	19.7 13.2
T103N	103 4.00	78 3.00	3,142 1.87	2,270 510.5	1,800 404.8	106.7 4.20	25.3 17.0
T103S	103 4.00	51 2.00	5,677 8.80	3,660 823.0	2,670 600.4	106.7 4.20	44.6 30.0

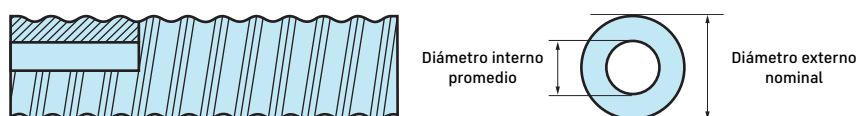

Barra hueca roscada "R"								
Designación de la barra	Diámetro externo nominal	Diámetro interno promedio	Diámetro externo real	Área transversal promedio	Carga máxima	Carga de fluencia	Diámetro mayor aproximado de la rosca	Peso nominal
	mm in	mm in	mm in	mm ² in ²	kN kips	kN kips	mm in	kg/m lbs/ft
R38Nx19	38 1.50	19 0.75	35.7 1.41	717 1.11	498 112	382 86	41 1.62	5.08 3.415
R51N	51 2.01	33 1.30	47.8 1.88	939 1.46	787 177	627 141	54 2.13	8.5 5.7

Nota: Como continuamente mejoramos el diseño de nuestros productos, los detalles del producto están sujetos a cambios.

SISTEMAS DE BARRA HUECA

COPLE CORRIDO DE UNIÓN

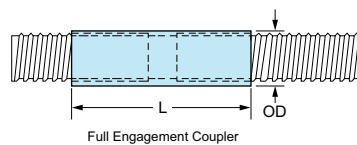

TUERCAS HEXAGONALES

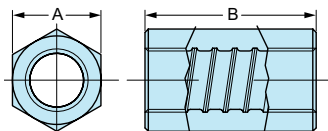

CENTRADORES

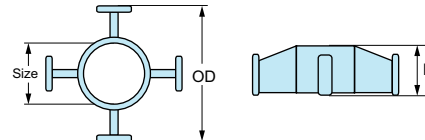

Coples "T" para barras huecas

Designación de la barra	OD		Peso
	mm	L	
	in	in	kg
			lbs
T40/20	53	140	1.18
	2.1	5.5	2.6
T40/16	53	140	1.18
	2.1	5.5	2.6
T52/30	68.5	160	2.36
	2.7	6.25	5.2
T76N	97	200	4.54
	3.8	8.0	10.2
T76S	97	220	6.53
	3.8	8.7	14.4
T103	132	292	13.8
	5.2	11.5	30.5

Tuercas hexagonales "T" para barras huecas

Designación de la barra	A		Peso
	mm	B	
	mm	in	kg
	in	in	lbs
T40/20	64.0	50.0	1.22
	2.5	2.0	2.7
T40/16	64.0	50.0	1.18
	2.5	2.0	2.6
T52/26	81	63.5	2.31
	3.2	2.5	5.1
T76N	102.0	80.0	2.81
	4.0	3.1	6.2
T76S	102.0	80.0	2.81
	4.0	3.1	6.2
T103	133.0	130.0	5.90
	5.25	5.125	13.0

Centradores para barra hueca

Barra	OD		Peso
	mm	L	
	mm	in	kg
	in	in	lbs
T30	70	35	0.21
	2.75	1.40	0.5
T40	88	35	0.27
	3.40	1.40	0.6
T52	88	40	0.37
	3.40	1.50	0.8
T76	112	35	0.41
	4.40	1.40	1.0
T103	130	45	0.89
	5.00	1.75	2.0
T103	165	80	2.94
	6.40	3.20	6.5

Coples "R" para barras huecas

Designación de la barra	OD		Peso
	mm	L	
	mm	in	kg
	in	in	lbs
R38Nx19	64	220	172
	2.5	8.7	3.8
R51N	64	200	191
	2.5	8.0	4.2

Tuercas hexagonales "R" para barras huecas

Designación de la barra	A		Peso
	mm	B	
	mm	in	kg
	in	in	lbs
R38Nx19	51.0	60.0	0.59
	2.0	2.0	1.3
R51N	76.0	70.0	1.59
	3.0	3.0	3.5

DOMÉSTICA

SISTEMAS DE BARRA HUECA

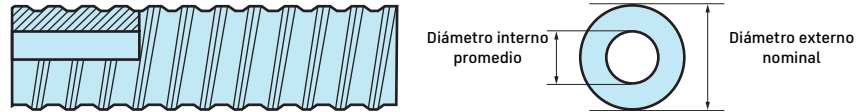

Barra hueca roscada "T"							
Designación de la barra	Diámetro externo nominal	Diámetro interno promedio	Área transversal promedio	Carga máxima	Carga de fluencia	Diámetro mayor aproximado de la rosca	Peso nominal
	mm in	mm in	mm ² in ²	kN kips	kN kips	mm in	kg/m lbs/ft
T40/16	40 1.57	16 0.63	879 1.36	660 148	525 118	41.3 1.625	7.3 4.9
T40/20	40 1.57	20 0.79	726 1.13	565 127	425 95.6	43.2 1.70	6.5 4.4
T52/26	52 2.05	26 1.03	1337 2.07	1009 227	796 179	54.0 2.125	10.1 6.8
T76/51	76 3.00	51 2.01	2065 3.20	1418 319	1120 252	76.2 3.000	16.5 11.1
T76S	76 3.00	45 1.77	2516 3.90	1859 418	1467 330	76.2 3.000	19.7 13.2

COPLÉ CORRIDO DE UNIÓN

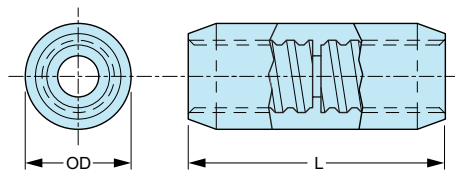

Coples "T" para barras huecas*			
Designación de la barra	OD	L	Peso
	mm in	mm in	kg lbs
HBC 40	63.5 2.500	139.7 5.50	2.31 5.10
HBC 40C	63.5 2.500	139.7 5.50	2.31 5.10
HBC 52	79.375 3.125	152.4 6.00	5.17 11.39
HBC 76O	95.25 3.75	200.03 7.875	15.79 34.81

TUERCAS HEXAGONALES DE ANCLAJE

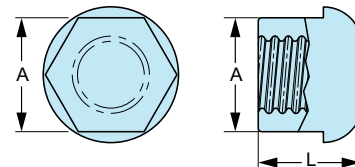

Tuercas hexagonales de anclaje para barra hueca			
Designación de la barra	A	L	Peso
	mm in	mm in	kg lbs
HBAN 40	63.5 2.50	50.8 2.0	2.66 5.87
HBAN 52	85.09 3.35	76.2 3.0	4.55 10.04
HBAN 76O	101.6 4.00	78.7 3.1	10.80 23.81

Cumple con los requisitos de "Buy America"

SISTEMAS DE BARRA HUECA

Cruce de carburo, corte cruzado de acero, y brocas de botón		
Designación de la barra	Designación	Peso
	mm in	kg/unidad lb/unidad
T30	50.8 2.0	0.45 1.0
	63.5 2.5	0.91 2.0
	76.2 3.0	1.32 2.9
T40	63.5 2.5	0.91 2.0
	76.2 3.0	1.32 2.9
	88.9 3.5	1.59 3.5
	101.6 4.0	2.49 5.5
	114.3 4.5	3.18 7.0
	127.0 5.0	4.76 10.5
	152.4 6.0	5.90 13.0
T52	114.3 4.5	3.18 7.0
	127.0 5.0	4.76 10.5
	152.4 6.0	5.90 13.0
T76	127.0 5.0	4.76 10.5
	152.4 6.0	5.90 13.0
	177.8 7.0	6.58 14.5
	203.2 8.0	7.26 16.0
R32	50.8 2.0	0.45 1.0
	63.5 2.5	0.91 2.0
	76.2 3.0	1.32 2.9
R38	76.2 3.0	1.32 2.9
	1.59 3.5	1.59 3.5
R51	101.6 4.0	2.49 5.5
	114.3 4.5	3.18 7.0
	127.0 5.0	4.76 10.5
	152.4 6.0	5.90 13.0

Todas las brocas están sujetas a la disponibilidad. Las brocas especiales están disponibles a petición.

Adaptadores de brocas	
Adaptadores	Peso
	kg/unidad lb/unidad
R32 x R38	0.09 0.20
R38 x R51	0.13 0.30
T30 x T40	0.13 0.30

Llámenos para cotizaciones específicas de algún trabajo. El precio depende de las cantidades.



PRIMER DOMÉSTICO

REVESTIMIENTO DE MICROPILOTES

Diámetro exterior	Ancho	Diámetro interno	Peso	Área de la sección transversal	Área de la punta	Volumen interno	Área del fuste	Momento de inercia	Módulo de sección
mm in	mm in	mm in	kg/m lb/ft	cm ² in ²	cm ² in ²	m ³ /m ft ³ /ft	m ² /m ft ² /ft	cm ⁴ in ⁴	cm ³ in ³
139.700 5.500	10.541 0.415	118.618 4.670	329.34 22.56	42.77 6.63	153.28 23.76	0.011 0.12	0.44 1.44	897.83 21.57	128.54 7.84
168.275 6.625	10.973 0.432	146.329 5.761	417.53 28.60	54.23 8.40	222.40 34.47	0.017 0.18	0.53 1.73	1685.34 40.49	200.31 12.22
177.800 7.000	10.363 0.408	157.073 6.184	419.74 28.75	54.51 8.45	248.29 38.48	0.019 0.21	0.56 1.83	1917.63 46.07	215.71 13.16
177.800 7.000	11.506 0.453	154.787 6.094	462.85 31.70	60.11 9.32	248.29 38.48	0.019 0.20	0.56 1.83	2087.81 50.16	234.85 14.33
177.800 7.000	12.700 0.500	152.400 6.000	507.21 34.74	65.87 10.21	248.29 38.48	0.018 0.20	0.56 1.83	2257.69 54.24	253.96 15.50
193.675 7.625	10.922 0.430	171.831 6.765	482.84 33.07	62.71 9.72	294.60 45.66	0.023 0.25	0.61 2.00	2627.25 63.12	271.31 16.56
193.675 7.625	12.700 0.500	168.275 6.625	555.98 38.08	72.21 11.19	294.60 45.66	0.022 0.24	0.61 2.00	2970.64 71.37	306.77 18.72
219.075 8.625	12.700 0.500	193.675 7.625	634.01 43.43	82.34 12.76	376.94 58.43	0.029 0.32	0.69 2.26	4400.21 105.72	401.71 24.51
219.075 8.625	14.275 0.562	190.525 7.501	707.19 48.44	91.84 14.24	376.94 58.43	0.029 0.31	0.69 2.26	4838.63 116.25	441.73 26.96
244.475 9.625	11.989 0.472	220.497 8.681	674.23 46.18	87.56 13.57	469.42 72.76	0.038 0.41	0.77 2.52	5931.68 142.51	485.26 29.61
244.475 9.625	13.843 0.545	216.789 8.535	772.30 52.90	100.30 15.55	469.42 72.76	0.037 0.40	0.77 2.52	6692.80 160.80	547.52 33.41
273.050 10.750	12.700 0.500	247.650 9.750	799.83 54.79	103.87 16.10	585.56 90.76	0.048 0.52	0.86 2.81	8821.97 211.95	646.18 39.43
273.050 10.75	13.843 0.545	245.364 9.660	867.99 59.46	112.73 17.47	585.56 90.76	0.047 0.51	0.86 2.81	9494.33 228.10	695.43 42.44
273.050 10.75	15.113 0.595	242.824 9.560	942.98 64.59	122.47 18.98	585.56 90.76	0.046 0.50	0.86 2.81	10219.67 245.53	748.56 45.68
301.624 11.875	14.783 0.582	272.059 10.711	1025.74 70.26	133.21 20.65	714.53 110.75	0.058 0.63	0.95 3.11	13737.09 330.04	910.87 55.59
323.849 12.75	12.700 0.500	298.449 11.750	955.89 65.48	124.14 19.24	823.71 127.68	0.070 0.75	1.02 3.34	15048.49 361.54	929.35 56.71
339.724 13.375	12.192 0.480	315.340 12.415	965.98 66.17	125.45 19.45	906.45 140.50	0.078 0.84	1.07 3.50	16846.06 404.73	991.75 60.52
339.724 13.375	13.056 0.514	313.613 12.347	1031.67 70.67	133.98 20.77	906.45 140.50	0.077 0.83	1.07 3.50	17900.79 430.07	1053.84 64.31
406.4 16	9.525 0.375	387.35 15.25	93.23 62.64	118.76 18.41	1333.17 201.06	0.12 1.27	1.28 4.19	23395.71 562.08	1151.36 70.26
406.4 16	11.125 0.438	384.15 15.124	108.45 72.87	138.15 21.41	1333.17 201.06	0.12 1.25	1.28 4.19	27002.81 648.75	1328.88 81.09
406.4 16	12.573 0.495	381.254 15.01	122.11 82.04	155.56 24.11	1333.17 201.6	0.11 1.23	1.28 4.19	30189.62 725.31	1485.71 90.66
457.2 18	11.049 0.435	435.102 17.13	121.57 81.68	154.87 24	1641.73 254.47	0.15 1.60	1.44 4.71	38856.25 926.32	1686.63 102.93
508 20	11.125 0.438	485.75 19.124	136.12 91.59	173.66 26.92	2026.83 314.16	0.19 1.99	1.60 5.24	53619.94 1288.22	2111.02 128.82
508 20	16.129 0.635	475.742 18.73	195.65 131.45	249.23 38.63	2026.83 314.16	0.18 1.91	1.60 5.24	75454.95 1812.81	2970.67 181.28

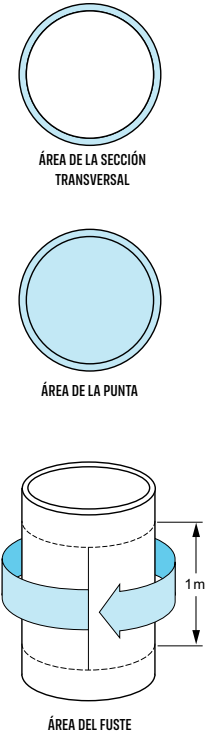

Póngase en contacto con su representante de Nucor Skyline para obtener diámetros, longitudes y detalles de arranque adicionales.

SISTEMAS DE BARRA HUECA

Diámetro exterior	Ancho	Diámetro interno	Peso	Área de la sección transversal	Área de la punta	Volumen interno	Área del fuste	Momento de inercia	Módulo de sección
mm in	mm in	mm in	kg/m lb/ft	cm ² in ²	cm ² in ²	m ³ /m ft ³ /ft	m ² /m ft ² /ft	cm ⁴ in ⁴	cm ³ in ³
139.700 5.500	10.541 0.415	118.618 4.670	329.34 22.56	42.77 6.63	153.28 23.76	0.011 0.12	0.44 1.44	897.83 21.57	128.54 7.84
168.275 6.625	10.973 0.432	146.329 5.761	417.53 28.60	54.23 8.40	222.40 34.47	0.017 0.18	0.53 1.73	1685.34 40.49	200.31 12.22
177.800 7.000	10.363 0.408	157.073 6.184	419.74 28.75	54.51 8.45	248.29 38.48	0.019 0.21	0.56 1.83	1917.63 46.07	215.71 13.16
177.800 7.000	11.506 0.453	154.787 6.094	462.85 31.70	60.11 9.32	248.29 38.48	0.019 0.20	0.56 1.83	2087.81 50.16	234.85 14.33
177.800 7.000	12.700 0.500	152.400 6.000	507.21 34.74	65.87 10.21	248.29 38.48	0.018 0.20	0.56 1.83	2257.69 54.24	253.96 15.50
193.675 7.625	10.922 0.430	171.831 6.765	482.84 33.07	62.71 9.72	294.60 45.66	0.023 0.25	0.61 2.00	2627.25 63.12	271.31 16.56
193.675 7.625	12.700 0.500	168.275 6.625	555.98 38.08	72.21 11.19	294.60 45.66	0.022 0.24	0.61 2.00	2970.64 71.37	306.77 18.72
219.075 8.625	12.700 0.500	193.675 7.625	634.01 43.43	82.34 12.76	376.94 58.43	0.029 0.32	0.69 2.26	4400.21 105.72	401.71 24.51
219.075 8.625	14.275 0.562	190.525 7.501	707.19 48.44	91.84 14.24	376.94 58.43	0.029 0.31	0.69 2.26	4838.63 116.25	441.73 26.96
244.475 9.625	11.989 0.472	220.497 8.681	674.23 46.18	87.56 13.57	469.42 72.76	0.038 0.41	0.77 2.52	5931.68 142.51	485.26 29.61
244.475 9.625	13.843 0.545	216.789 8.535	772.30 52.90	100.30 15.55	469.42 72.76	0.037 0.40	0.77 2.52	6692.80 160.80	547.52 33.41
273.050 10.750	12.700 0.500	247.650 9.750	799.83 54.79	103.87 16.10	585.56 90.76	0.048 0.52	0.86 2.81	8821.97 211.95	646.18 39.43
273.050 10.75	13.843 0.545	245.364 9.660	867.99 59.46	112.73 17.47	585.56 90.76	0.047 0.51	0.86 2.81	9494.33 228.10	695.43 42.44
273.050 10.75	15.113 0.595	242.824 9.560	942.98 64.59	122.47 18.98	585.56 90.76	0.046 0.50	0.86 2.81	10219.67 245.53	748.56 45.68
301.624 11.875	14.783 0.582	272.059 10.711	1025.74 70.26	133.21 20.65	714.53 110.75	0.058 0.63	0.95 3.11	13737.09 330.04	910.87 55.59
323.849 12.75	12.700 0.500	298.449 11.750	955.89 65.48	124.14 19.24	823.71 127.68	0.070 0.75	1.02 3.34	15048.49 361.54	929.35 56.71
339.724 13.375	12.192 0.480	315.340 12.415	965.98 66.17	125.45 19.45	906.45 140.50	0.078 0.84	1.07 3.50	16846.06 404.73	991.75 60.52
339.724 13.375	13.056 0.514	313.613 12.347	1031.67 70.67	133.98 20.77	906.45 140.50	0.077 0.83	1.07 3.50	17900.79 430.07	1053.84 64.31
406.4 16	9.525 0.375	387.35 15.25	93.23 62.64	118.76 18.41	1333.17 201.06	0.12 1.27	1.28 4.19	23395.71 562.08	1151.36 70.26
406.4 16	11.125 0.438	384.15 15.124	108.45 72.87	138.15 21.41	1333.17 201.06	0.12 1.25	1.28 4.19	27002.81 648.75	1328.88 81.09
406.4 16	12.573 0.495	381.254 15.01	122.11 82.04	155.56 24.11	1333.17 201.6	0.11 1.23	1.28 4.19	30189.62 725.31	1485.71 90.66
457.2 18	11.049 0.435	435.102 17.13	121.57 81.68	154.87 24	1641.73 254.47	0.15 1.60	1.44 4.71	38856.25 926.32	1686.63 102.93
508 20	11.125 0.438	485.75 19.124	136.12 91.59	173.66 26.92	2026.83 314.16	0.19 1.99	1.60 5.24	53619.94 1288.22	2111.02 128.82
508 20	16.129 0.635	475.742 18.73	195.65 131.45	249.23 38.63	2026.83 314.16	0.18 1.91	1.60 5.24	75454.95 1812.81	2970.67 181.28

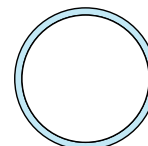

ÁREA DE LA SECCIÓN TRANSVERSAL

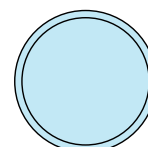

ÁREA DE LA PUNTA

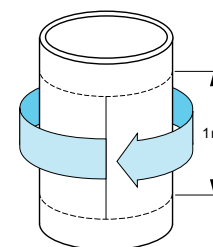

ÁREA DEL FUSTE

Póngase en contacto con su representante de Nucor Skyline para obtener diámetros, longitudes y detalles de arranque adicionales.

Nota: Como continuamente mejoramos el diseño de nuestros productos, los detalles del producto están sujetos a cambios.

REVESTIMIENTO DE MICROPILOTES

ACCESORIOS PARA MICROPILOTES

El grupo geoes estructural de Nucor Skyline tiene la capacidad de suministrar paquetes completos de accesorios junto con su micropilotes. Debido a que entendemos la urgencia de su proyecto, en Skyline poseemos en existencia una amplia variedad de accesorios para micropilotes de entrega inmediata.

HERRAMIENTAS Y ACCESORIOS

Disponemos de maquinado a medida para adaptadores dobles y de patín para cumplir con sus requisitos de micropilotes, y sistemas de perforación. También podemos fabricar collarines de transición que se adapten a cualquier herramienta existente. Nucor Skyline ofrece los siguientes artículos de herramental para la instalación de revestimientos con micropilotes:



Revestimiento roscado de micropilotes instalado con barras reforzadas 75 ksi completamente roscadas



Micropilotes hembra y macho cortados y empaquetados según especificaciones.



Tenemos sub-ahorradores disponibles para todos tamaños de revestimiento



Los accesorios para micropilotes incluyen adaptadores dobles y de brida.



Las brocas neumáticas se encuentran disponibles en varios tamaños y configuraciones de vástago.



Las barras de perforación y los collarines para micropilotes API son artículos de uso habitual.

SISTEMA DE ANCLAJES MULTITRENZAS

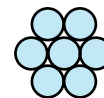
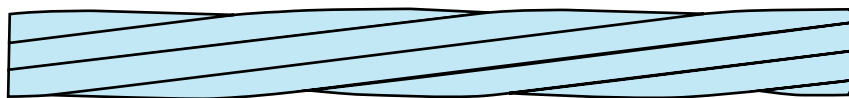

Sistema de anclajes multitrenzas – ASTM A-416

No. de trenzas	Área transversal nominal (Aps)	Resistencia máxima (Fpu x Aps)	Carga con gato máxima (0.8 x Fpu x Aps)	Carga de diseño máxima (0.6 x Fpu x Aps)	Mínima tensión real al final del bloqueo* (0.5 x Fpu x Aps)	Peso nominal del acero (trenza desnuda)
	mm ² in ²	kN kíps	kN kíps	kN kíps	kN kíps	kg/m lbs/ft
1	140 0.217	261 58.6	209 46.9	156 35.2	130 29.3	1.10 0.74
2	280 0.434	521 117.2	417 93.8	313 70.3	261 58.6	2.20 1.48
3	420 0.651	782 175.8	626 140.6	469 105.5	391 87.9	3.31 2.22
4	560 0.868	1043 234.4	834 187.5	626 140.6	521 117.2	4.41 2.96
5	700 1.085	1303 293.0	1043 234.4	782 175.8	652 146.5	5.51 3.70
6	840 1.302	1564 351.6	1251 281.3	938 211.0	782 175.8	6.61 4.44
7	980 1.519	1825 410.2	1460 328.2	1095 246.1	912 205.1	7.71 5.18
8	1120 1.736	2085 468.8	1668 375.0	1251 281.3	1043 234.4	8.82 5.92
9	1260 1.953	2346 527.4	1877 421.9	1408 316.4	1173 263.7	9.92 6.66
10	1400 2.170	2607 586.0	2085 468.8	1564 351.6	1303 293.0	11.02 7.40
11	1540 2.387	2867 644.6	2294 515.7	1720 386.8	1434 322.3	12.12 8.14
12	1680 2.604	3128 703.2	2503 562.6	1877 421.9	1564 351.6	13.22 8.88
13	1820 2.821	3389 761.8	2711 609.4	2033 457.1	1694 380.9	14.33 9.62
14	1960 3.038	3649 820.4	2920 656.3	2190 492.2	1825 410.2	15.43 10.36
15	2100 3.255	3910 879.0	3128 703.2	2346 527.4	1955 439.5	16.53 11.10
16	2240 3.472	4171 937.6	3337 750.1	2503 562.6	2085 468.8	17.63 11.84
17	2380 3.689	4432 996.2	3545 797.0	2659 597.7	2216 498.1	18.73 12.58
18	2520 3.906	4692 1054.8	3754 843.8	2815 632.9	2346 527.4	19.84 13.32
19	2660 4.123	4953 1113.4	3962 890.7	2972 668.0	2476 556.7	20.94 14.06

Aps = Área del Acero Pre-tensionado, Fpu = Mínima Resistencia a la Tracción Máxima

Torón constituido por 7 cables de acero de .6" (15.2 mm) de diámetro, grado 270 KSI de baja relajación conforme a la norma ASTM A 416.

* La Máxima tensión real al final del bloqueo no debe exceder de (0.7 x Fpu x Aps), la máxima carga con gato, no debe exceder de (0.8 x Fpu x Aps)

Ahora disponible: Torones recubiertos con fusión caliente extraída. Consulta a tu representante para distribución de carga o torones removibles.

Nota: Como continuamente mejoramos el diseño de nuestros productos, los detalles del producto están sujetos a cambios.

SISTEMA DE ANCLAJES MULTITRENZAS

DETALLES DEL ANCLAJE CON TRENZA DCP, CLASE I DE PTI

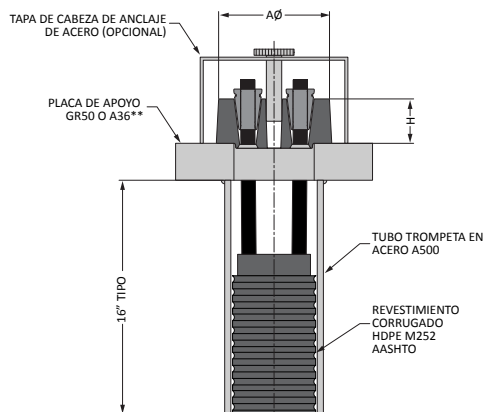

**Nucor Skyline le puede proveer de una solución de placas de apoyo personalizadas.

Dimensiones del cabezal del anclaje y del ducto para anclajes trenzados DCP

Número máximo de trenzas	Revestimiento corrugado		Tubo trompeta		Cabeza del anclaje		Tapa de cabeza de anclaje	
	OD mm in	ID mm in	OD mm in	ID mm in	AØ mm in	H mm in	OD mm in	Alto in mm
2-3*	59.18 2.33	50.80 2.00	101.60 4.00	90.12 3.548	119.38 4.70	45.72 1.80	141.29 5.56	88.90 3.50
4**	76.20 3.00	63.50 2.50	101.60 4.00	90.12 3.548	119.38 4.70	45.72 1.80	141.29 5.56	88.90 3.50
6*	76.20 3.00	63.50 2.50	101.60 4.00	90.12 3.548	142.49 5.61	55.88 2.20	168.28 6.63	114.30 4.50
8**	91.44 3.60	76.20 3.00	114.30 4.50	102.26 4.026	160.78 6.33	52.32 2.06	168.28 6.63	114.30 4.50
12**	116.84 4.60	101.60 4.00	141.29 5.56	128.18 5.047	165.10 6.50	42.93 1.69	219.08 8.63	114.30 4.50
19**	142.88 5.63	127.00 5.00	168.28 6.63	154.05 6.065	223.01 8.78	101.60 4.00	273.05 10.75	152.40 6.00

* La tabla anterior se basa en un tubo de PE para el enlechado con un diámetro externo de ¾ de pulgada, instalado dentro de revestimiento corrugado, se dispone de otras variaciones. Consulte a su representante de ventas.

Nota: Como continuamente mejoramos el diseño de nuestros productos, los detalles del producto están sujetos a cambios.



NUCOR®

SKYLINE

www.nucorskyline.com/es | México, América Central y Colombia: **+52 442.218.5511**

Acerca de Nucor Skyline

Como la principal compañía proveedora de soluciones en acero estructural para cimentaciones y edificios, Nucor Skyline ofrece una variedad incomparable de productos. Nucor Skyline es una subsidiaria de Nucor Corporation, el mayor productor de acero en los Estados Unidos.